

PM200CL1A060

FLAT-BASE TYPE
INSULATED PACKAGE

PM200CL1A060



FEATURE

Inverter + Drive & Protection IC

- a) Adopting new 5th generation Full-Gate CSTBT™ chip
- b) The over-temperature protection which detects the chip surface temperature of CSTBT™ is adopted.
- c) Error output signal is possible from all each protection upper and lower arm of IPM.
- d) Compatible L-series package.

- 3φ 200A, 600V Current-sense and temperature sense IGBT type inverter
- Monolithic gate drive & protection logic
- Detection, protection & status indication circuits for, short-circuit, over-temperature & under-voltage (P-FO available from upper arm devices)
- UL Recognized

APPLICATION

General purpose inverter, servo drives and other motor controls

PACKAGE OUTLINES

Dimensions in mm

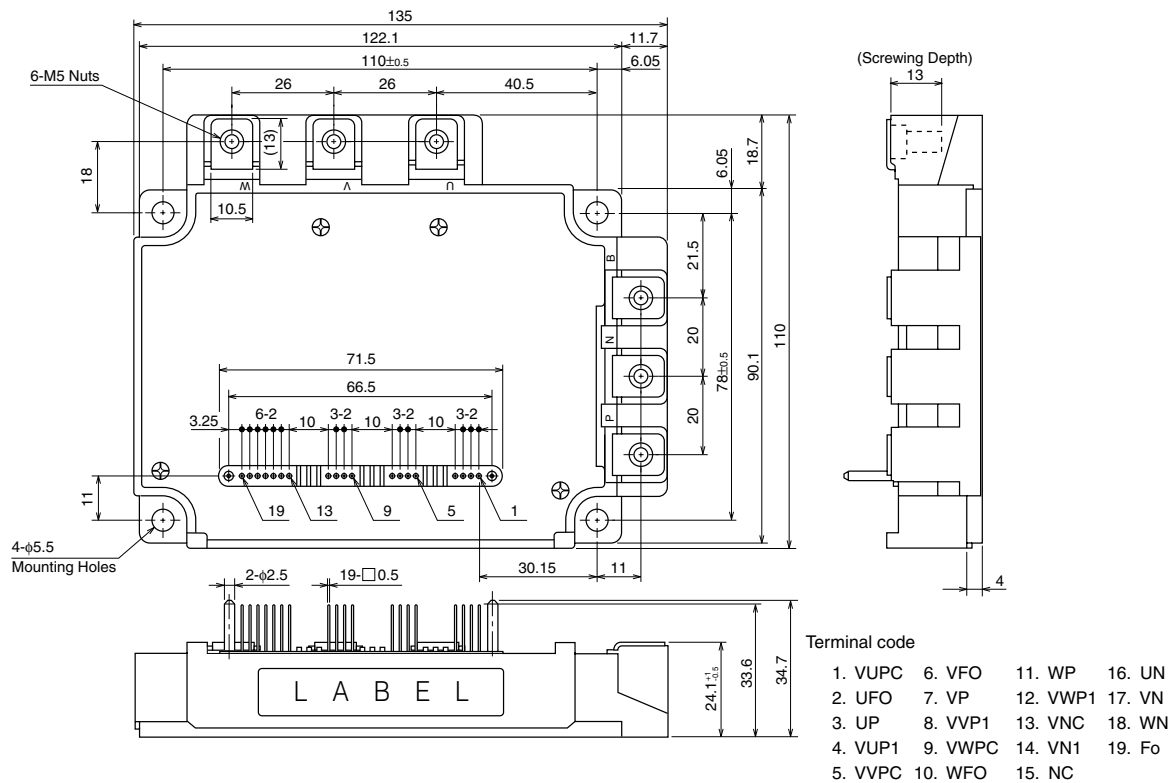

PM200CL1A060

FLAT-BASE TYPE
INSULATED PACKAGE

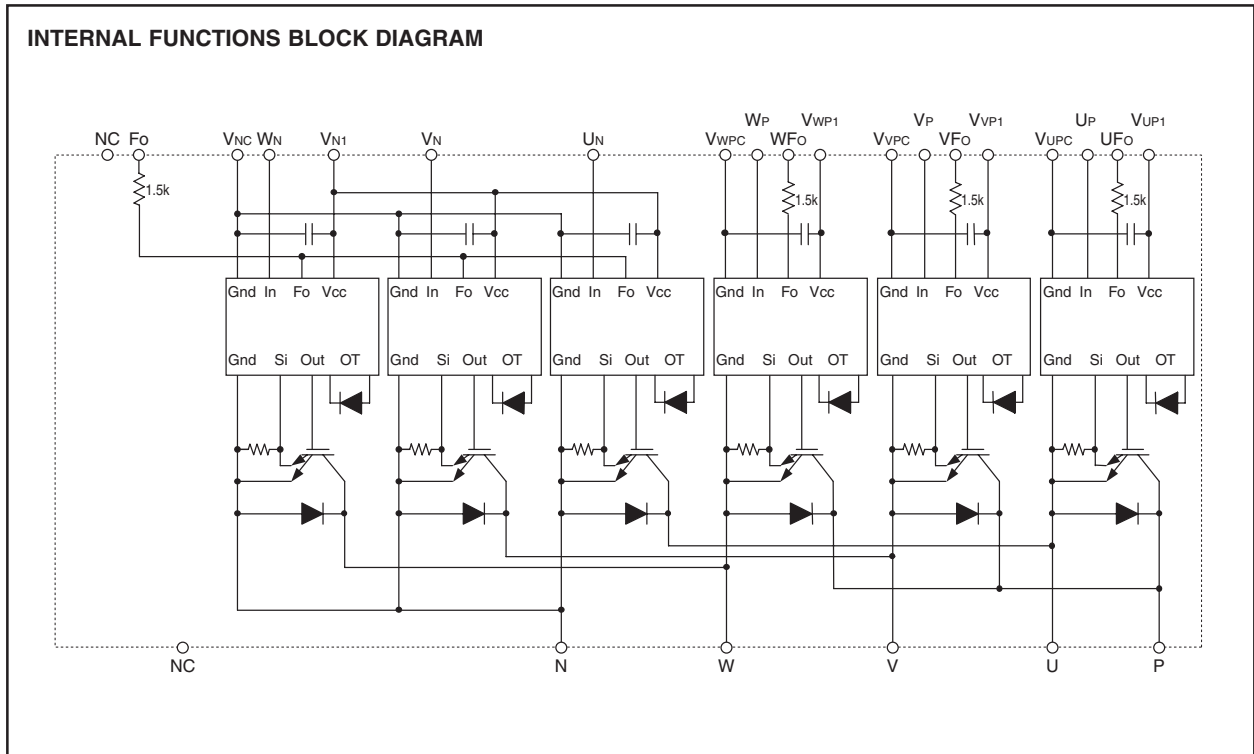

MAXIMUM RATINGS ($T_j = 25^\circ\text{C}$, unless otherwise noted)

INVERTER PART

Symbol	Parameter	Condition	Ratings	Unit
V_{CES}	Collector-Emitter Voltage	$V_D = 15\text{V}$, $V_{CIN} = 15\text{V}$	600	V
$\pm I_C$	Collector Current	$T_C = 25^\circ\text{C}$ (Note-1)	200	A
$\pm I_{CP}$	Collector Current (Peak)	$T_C = 25^\circ\text{C}$	400	A
P_C	Collector Dissipation	$T_C = 25^\circ\text{C}$ (Note-1)	625	W
T_j	Junction Temperature		-20 ~ +150	$^\circ\text{C}$

*: T_c measurement point is just under the chip.

CONTROL PART

Symbol	Parameter	Condition	Ratings	Unit
V_D	Supply Voltage	Applied between : $V_{UP1}-V_{UPC}$, $V_{VP1}-V_{VPC}$ $V_{WP1}-V_{WPC}$, $V_{N1}-V_{NC}$	20	V
V_{CIN}	Input Voltage	Applied between : U_P-V_{UPC} , V_P-V_{VPC} , W_P-V_{WPC} $U_N \cdot V_N \cdot W_N - V_{NC}$	20	V
V_{FO}	Fault Output Supply Voltage	Applied between : $U_{FO}-V_{UPC}$, $V_{FO}-V_{VPC}$, $W_{FO}-V_{WPC}$ $F_O - V_{NC}$	20	V
I_{FO}	Fault Output Current	Sink current at U_{FO} , V_{FO} , W_{FO} , F_O terminals	20	mA

PM200CL1A060

FLAT-BASE TYPE
INSULATED PACKAGE

TOTAL SYSTEM

Symbol	Parameter	Conditions	Ratings	Unit
$V_{CC(Prot)}$	Supply Voltage Protected by SC	$V_D = 13.5V \sim 16.5V$ Inverter Part, $T_j = +125^\circ C$ Start	400	V
$V_{CC(surge)}$	Supply Voltage (Surge)	Applied between : P-N, Surge value	500	V
T_{stg}	Storage Temperature		-40 ~ +125	$^\circ C$
V_{iso}	Isolation Voltage	60Hz, Sinusoidal, Charged part to Base plate, AC 1min, RMS	2500	V

*: T_C measurement point is just under the chip.

THERMAL RESISTANCE

Symbol	Parameter	Conditions	Limits			Unit
			Min.	Typ.	Max.	
$R_{th(j-c)Q}$	Thermal Resistance	Inverter, IGBT (per 1 element) (Note.1)	-	-	0.20	$^\circ C/W$
$R_{th(j-c)F}$		Inverter, FWDi (per 1 element) (Note.1)	-	-	0.30	
$R_{th(c-f)}$	Contact Thermal Resistance	Case to fin, (per 1 module) Thermal grease applied (Note.1)	-	-	0.023	

Note.1: If you use this value, $R_{th(f-a)}$ should be measured just under the chips.

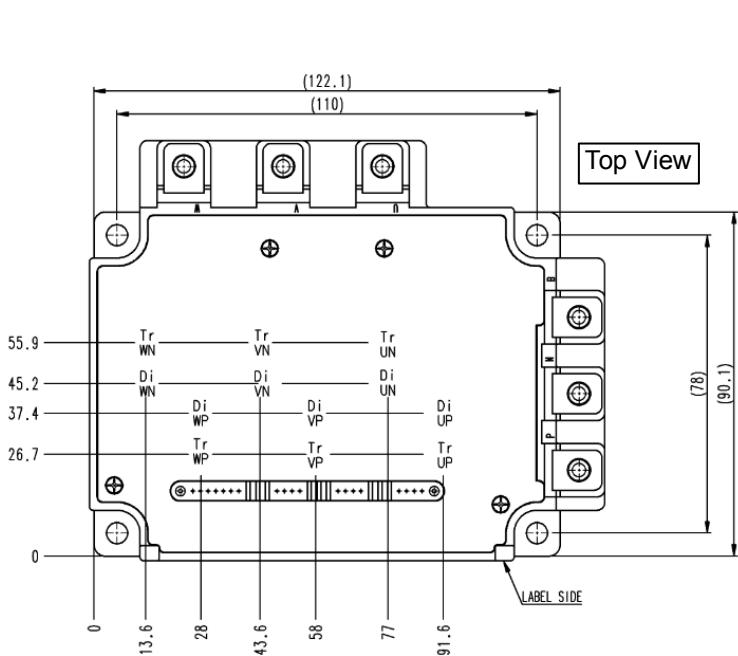

PM200CL1A060

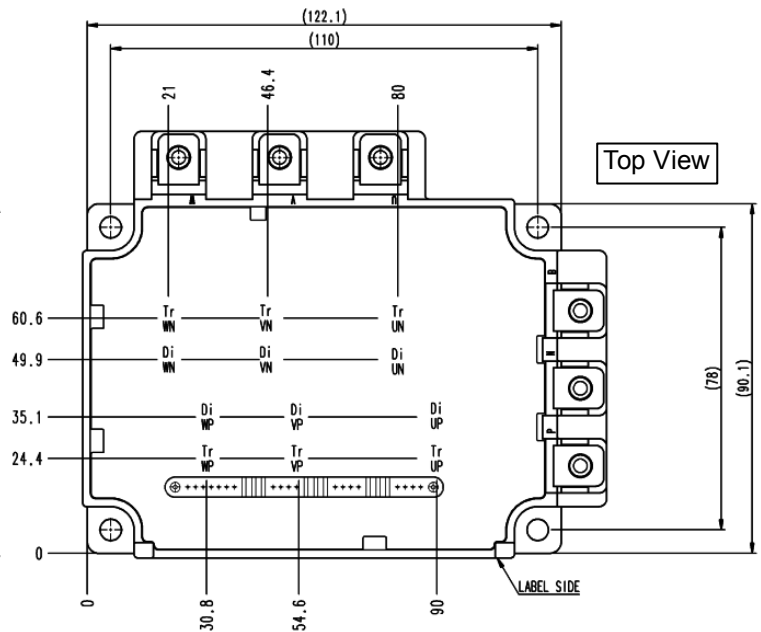

PM200CL1A060 350G

* "350G" is printed on the label

ELECTRICAL CHARACTERISTICS ($T_j = 25^\circ C$, unless otherwise noted)

INVERTER PART

Symbol	Parameter	Conditions	Limits			Unit
			Min.	Typ.	Max.	
$V_{CE(sat)}$	Collector-Emitter Saturation Voltage	$V_D = 15V, I_C = 200A$ $V_{CIN} = 0V$, Pulsed (Fig. 1)	$T_j = 25^\circ C$ -	1.75	2.35	V
V_{EC}	FwDi Forward Voltage	$-I_C = 200A, V_D = 15V, V_{CIN} = 15V$ (Fig. 2)	-	1.7	2.8	V
t_{on}	Switching Time	$V_D = 15V, V_{CIN} = 0V \leftrightarrow 15V$ $V_{CC} = 300V, I_C = 200A$ $T_j = 125^\circ C$ Inductive Load (Fig. 3,4)	0.3	0.8	2.0	μs
t_{rr}			-	0.4	0.8	
$t_{c(on)}$			-	0.4	1.0	
t_{off}			-	1.0	2.3	
$t_{c(off)}$			-	0.3	1.0	
I_{CES}	Collector-Emitter Cut-off Current	$V_{CE} = V_{CES}, V_D = 15V, V_{CIN} = 15V$ (Fig. 5)	$T_j = 25^\circ C$ -	-	1	mA
			$T_j = 125^\circ C$ -	-	10	

PM200CL1A060

FLAT-BASE TYPE
INSULATED PACKAGE

CONTROL PART

Symbol	Parameter	Condition	Limits			Unit	
			Min.	Typ.	Max.		
ID	Circuit Current	$V_D = 15V, V_{CIN} = 15V$	V_{N1-VNC}	—	6	12	mA
			V_{P1-VPC}	—	2	4	
$V_{th(ON)}$	Input ON Threshold Voltage	Applied between : UP-VUPC, VP-VVPC, WP-VWPC $U_N \cdot V_N \cdot W_N - V_{NC}$	1.2	1.5	1.8	V	
$V_{th(OFF)}$	Input OFF Threshold Voltage		1.7	2.0	2.3		
SC	Short Circuit Trip Level	$-20 \leq T_j \leq 125^\circ C, V_D = 15V$ (Fig. 3,6)	400	—	—	A	
$t_{off(SC)}$	Short Circuit Current Delay Time	$V_D = 15V$ (Fig. 3,6)	—	0.2	—	μs	
OT	Over Temperature Protection	Detect Temperature of IGBT chip	Trip level	135	—	—	$^\circ C$
$OT_{(hys)}$			Hysteresis	—	20	—	
UV	Supply Circuit Under-Voltage Protection	$-20 \leq T_j \leq 125^\circ C$	Trip level	11.5	12.0	12.5	V
UV_r			Reset level	—	12.5	—	
$I_{FO(H)}$	Fault Output Current	$V_D = 15V, V_{CIN} = 15V$ (Note-2)	—	—	0.01	mA	
$I_{FO(L)}$			—	10	15		
t_{FO}	Minimum Fault Output Pulse Width	$V_D = 15V$ (Note-2)	1.0	1.8	—	ms	

(Note-2) Fault output is given only when the internal SC, OT & UV protections schemes of either upper or lower arm device operate to protect it.

MECHANICAL RATINGS AND CHARACTERISTICS

Symbol	Parameter	Condition	Limits			Unit
			Min.	Typ.	Max.	
—	Mounting torque	Mounting part screw : M5	2.5	3.0	3.5	N • m
		Main terminal part screw : M5	2.5	3.0	3.5	
—	Weight	—	—	800	—	g

RECOMMENDED CONDITIONS FOR USE

Symbol	Parameter	Condition	Recommended value	Unit
V_{CC}	Supply Voltage	Applied across P-N terminals	≤ 400	V
V_D	Control Supply Voltage	Applied between : VUP1-VUPC, VVP1-VVPC VWP1-VWPC, VN1-VNC (Note-3)	15.0 ± 1.5	V
$V_{CIN(ON)}$	Input ON Voltage	Applied between : UP-VUPC, VP-VVPC, WP-VWPC $U_N \cdot V_N \cdot W_N - V_{NC}$	≤ 0.8	V
$V_{CIN(OFF)}$	Input OFF Voltage		≥ 9.0	
f_{PWM}	PWM Input Frequency	Using Application Circuit of Fig. 8	≤ 20	kHz
t_{dead}	Arm Shoot-through Blocking Time	For IPM's each input signals (Fig. 7)	≥ 2.0	μs

(Note-3) With ripple satisfying the following conditions: dv/dt swing $\leq \pm 5V/\mu s$, Variation $\leq 2V$ peak to peak

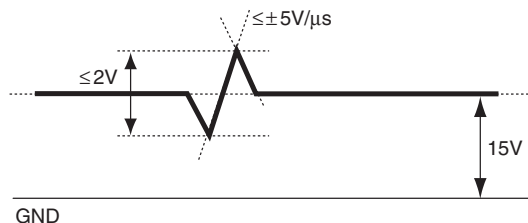

PM200CL1A060

FLAT-BASE TYPE
INSULATED PACKAGE

PRECAUTIONS FOR TESTING

1. Before applying any control supply voltage (V_D), the input terminals should be pulled up by resistors, etc. to their corresponding supply voltage and each input signal should be kept off state.
After this, the specified ON and OFF level setting for each input signal should be done.
2. When performing "SC" tests, the turn-off surge voltage spike at the corresponding protection operation should not be allowed to rise above V_{CES} rating of the device.
(These test should not be done by using a curve tracer or its equivalent.)

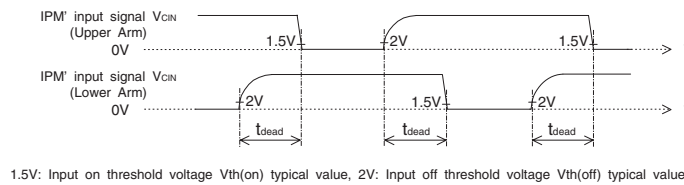
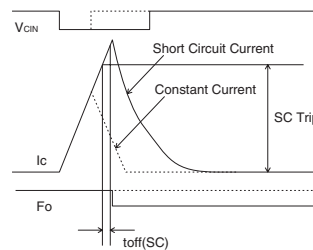
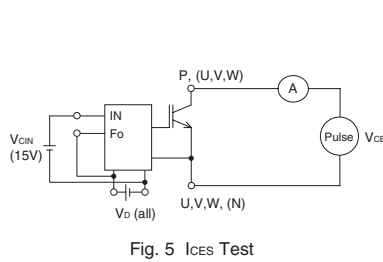
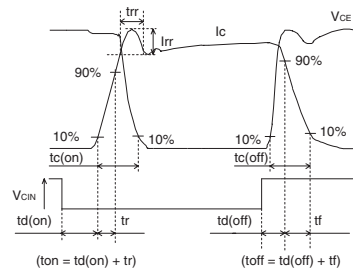
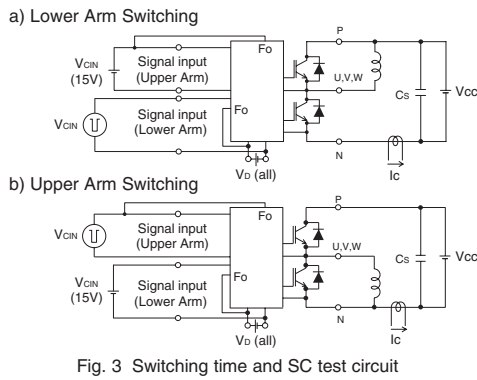
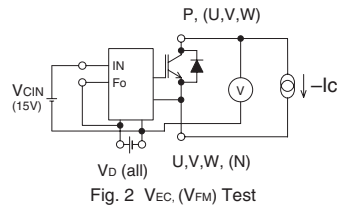
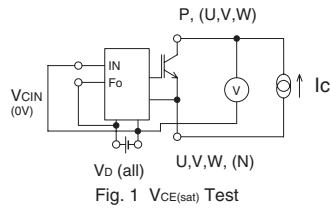

PM200CL1A060

FLAT-BASE TYPE
INSULATED PACKAGE

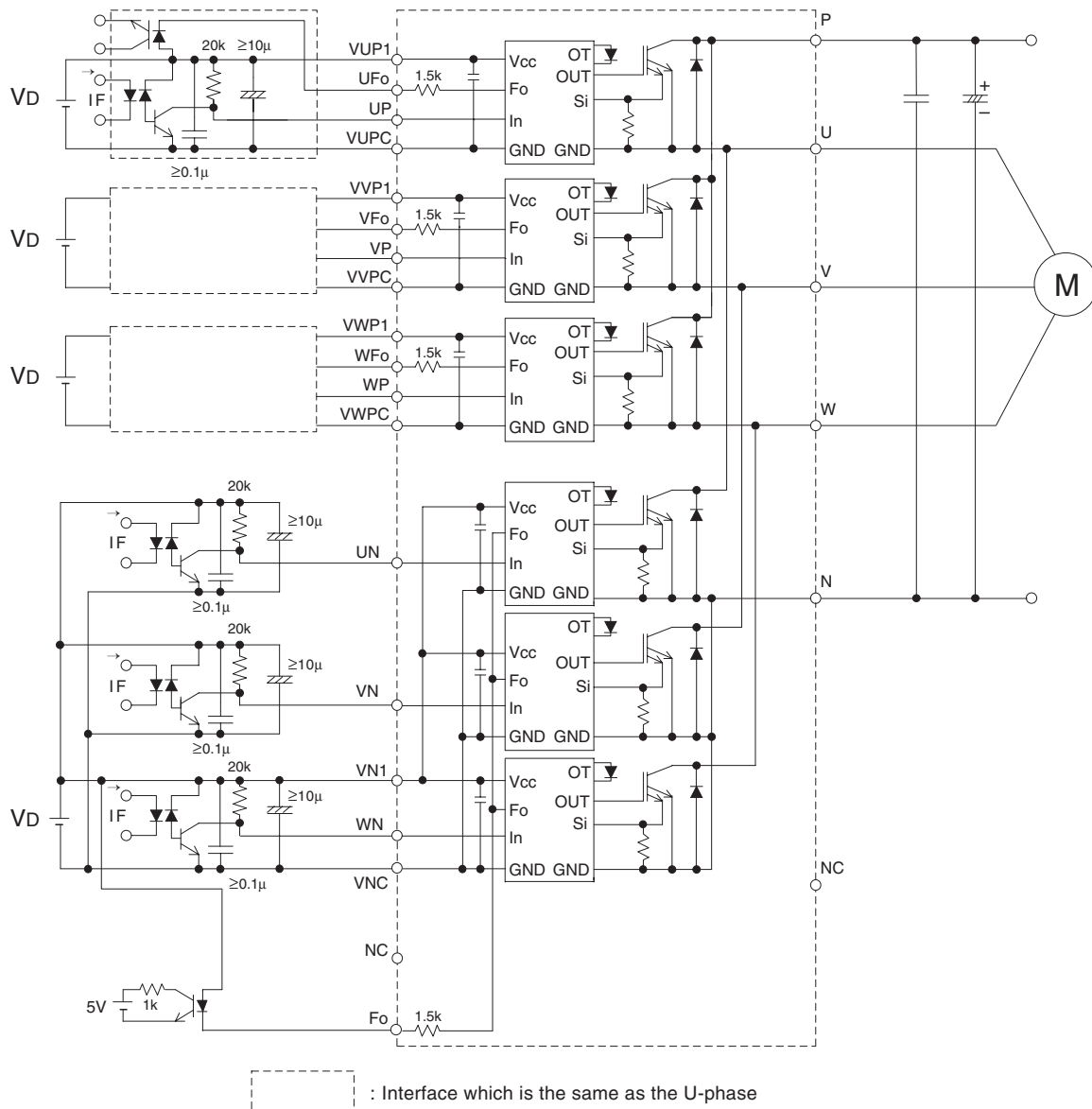

Fig. 8 Application Example Circuit

NOTES FOR STABLE AND SAFE OPERATION ;

- Design the PCB pattern to minimize wiring length between opto-coupler and IPM's input terminal, and also to minimize the stray capacity between the input and output wirings of opto-coupler.
- Connect low impedance capacitor between the Vcc and GND terminal of each fast switching opto-coupler.
- Fast switching opto-couplers: $t_{PLH}, t_{PHL} \leq 0.8\mu s$, Use High CMR type.
- Slow switching opto-coupler: CTR > 100%
- Use 4 isolated control power supplies (VD). Also, care should be taken to minimize the instantaneous voltage charge of the power supply.
- Make inductance of DC bus line as small as possible, and minimize surge voltage using snubber capacitor between P and N terminal.
- Use line noise filter capacitor (ex. 4.7nF) between each input AC line and ground to reject common-mode noise from AC line and improve noise immunity of the system.

PM200CL1A060

FLAT-BASE TYPE
INSULATED PACKAGE

PERFORMANCE CURVES

OUTPUT CHARACTERISTICS (TYPICAL)

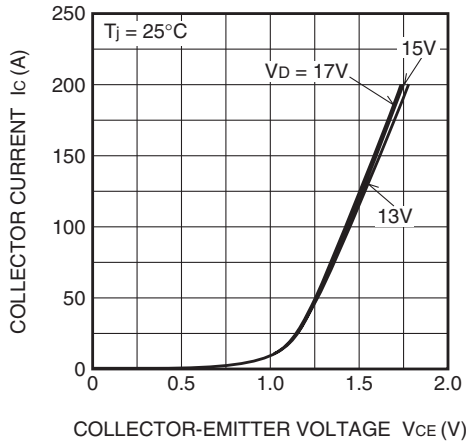

COLLECTOR-EMITTER SATURATION VOLTAGE (VS. I_c) CHARACTERISTICS (TYPICAL)

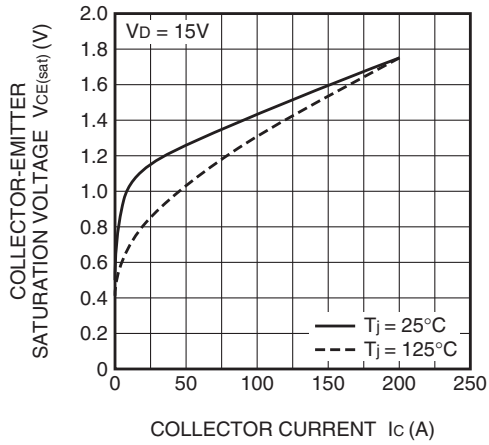

COLLECTOR-EMITTER SATURATION VOLTAGE (VS. V_D) CHARACTERISTICS (TYPICAL)

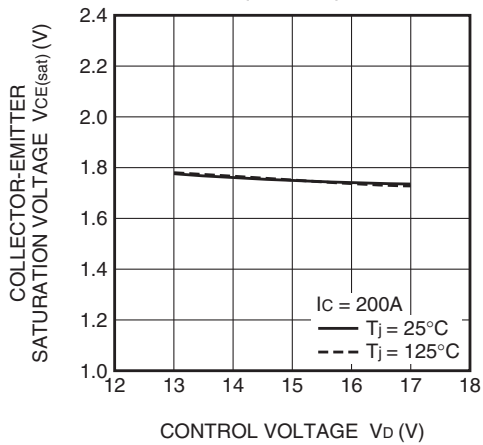

DIODE FORWARD CHARACTERISTICS (TYPICAL)

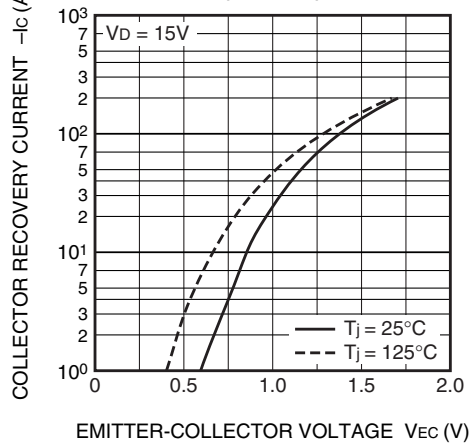

SWITCHING TIME (t_{on} , t_{off}) CHARACTERISTICS (TYPICAL)

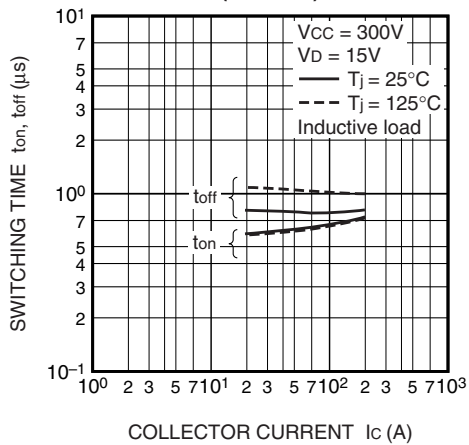

SWITCHING TIME ($t_{c(on)}$, $t_{c(off)}$) CHARACTERISTICS (TYPICAL)

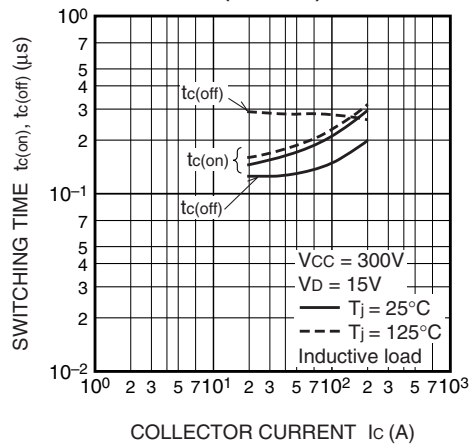

PM200CL1A060

FLAT-BASE TYPE
INSULATED PACKAGE

SWITCHING LOSS CHARACTERISTICS (TYPICAL)

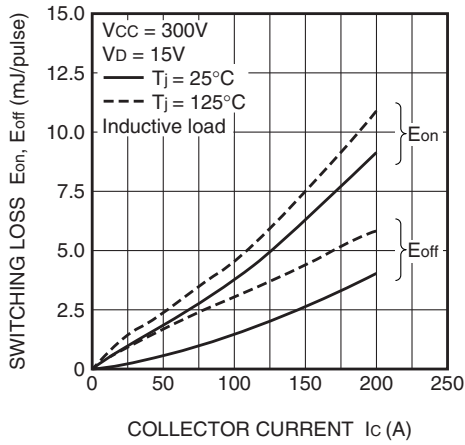

DIODE REVERSE RECOVERY CHARACTERISTICS (TYPICAL)

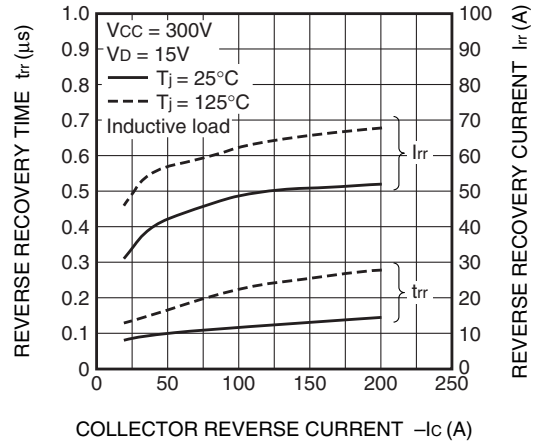

SWITCHING RECOVERY LOSS CHARACTERISTICS (TYPICAL)

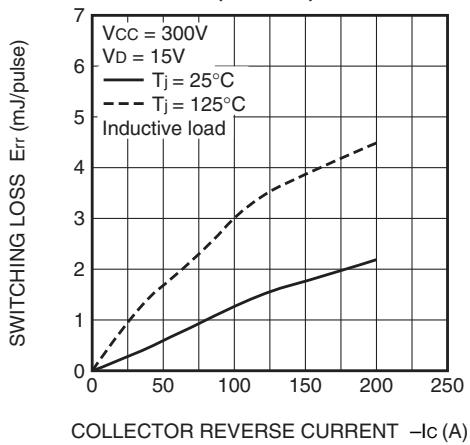

I_D VS. f_c CHARACTERISTICS (TYPICAL)

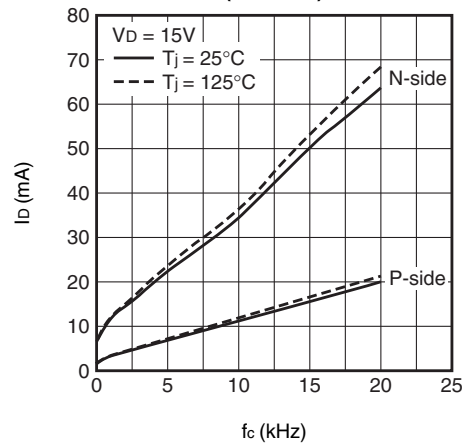

UV TRIP LEVEL VS. T_j CHARACTERISTICS (TYPICAL)

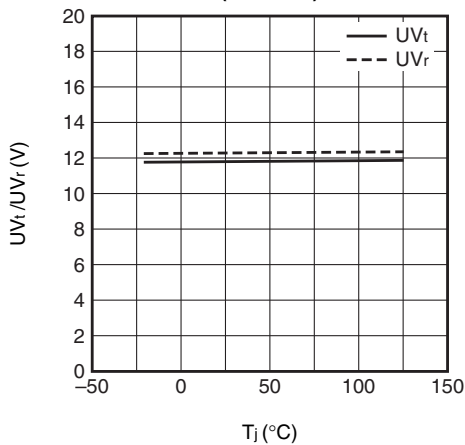

SC TRIP LEVEL VS. T_j CHARACTERISTICS (TYPICAL)

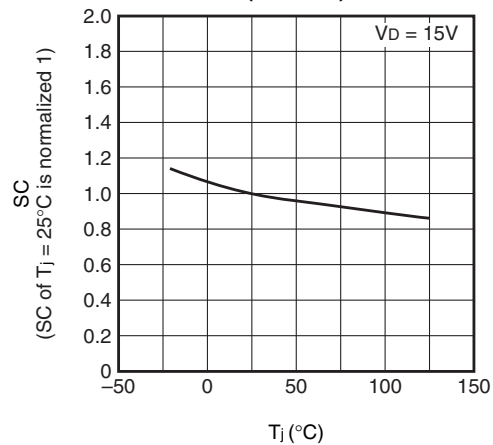

PM200CL1A060

FLAT-BASE TYPE
INSULATED PACKAGE

