

# 6MBP25VFN120-50

IGBT Modules

**IGBT Module (V series)**  
**1200V / 25A / IPM**

■ **Features**

- Temperature protection provided by directly detecting the junction temperature of the IGBTs
- Low power loss and soft switching
- High performance and high reliability IGBT with overheating protection
- Higher reliability because of a big decrease in number of parts in built-in control circuit

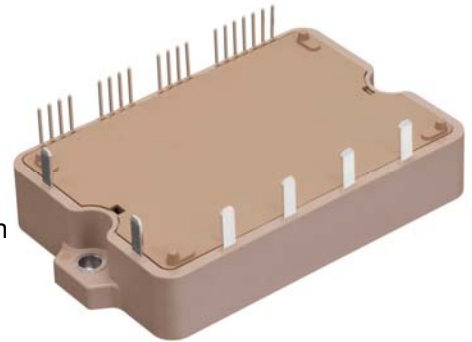

■ **Outline drawing ( Unit : mm )**

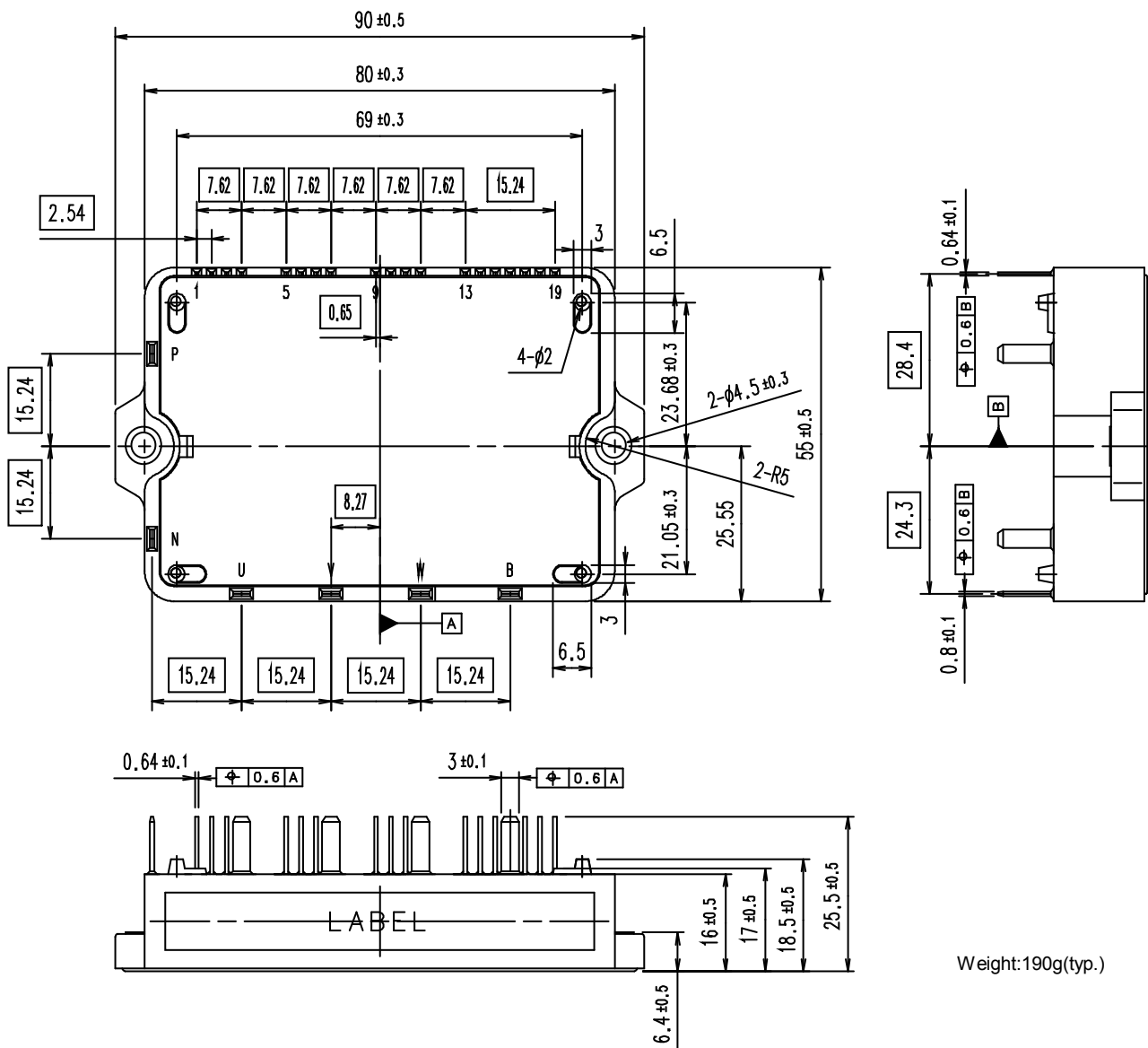

Weight: 190g(typ.)

# 6MBP25VFN120-50

**IGBT Modules**
**■ Absolute Maximum Ratings**
 $T_c=25^{\circ}\text{C}$ ,  $V_{CC}=15\text{V}$  unless otherwise specified.

Items		Symbol	Min.	Max.	Units
Collector-Emitter Voltage *1		$V_{CES}$	0	1200	V
Short Circuit Voltage		$V_{sc}$	400	800	V
Inverter	Collector Current	DC	-	25	A
		1ms	-	50	A
		Duty=100% *2	-	25	A
Collector Power Dissipation		1 device *3	-	271	W
Brake	Collector Current	DC	-	-	A
		1ms	-	-	A
		Forward Current of Diode	-	-	A
Collector Power Dissipation		1 device *3	-	-	W
Supply Voltage of Pre-Driver *4		$V_{CC}$	-0.5	20	V
Input Signal Voltage *5		$V_{in}$	-0.5	$V_{CC}+0.5$	V
Alarm Signal Voltage *6		$V_{ALM}$	-0.5	$V_{CC}$	V
Alarm Signal Current *7		$I_{ALM}$	-	20	mA
Junction Temperature		$T_j$	-	150	$^{\circ}\text{C}$
Operating Case Temperature		$T_{opr}$	-20	110	$^{\circ}\text{C}$
Storage Temperature		$T_{stg}$	-40	125	$^{\circ}\text{C}$
Solder Temperature *8		$T_{sol}$	-	260	$^{\circ}\text{C}$
Isolating Voltage *9		$V_{iso}$	-	AC2500	Vrms
Screw Torque		Mounting (M4)	-	1.7	Nm

**Notes**

\*1:  $V_{CES}$  shall be applied to the input voltage between terminal P-(U,V, W,B) and (U,V, W,B)-N.

\*2:  $Duty=125^{\circ}\text{C}/R_{th(j-c)D}/(I_F \times V_F \text{ Max.}) \times 100$

\*3:  $PC=125^{\circ}\text{C}/R_{th(j-c)Q}$  (Inverter & Brake)

\*4:  $V_{CC}$  shall be applied to the input voltage between terminal No.4 and 1, 8 and 5, 12 and 9,14 and 13.

\*5:  $V_{in}$  shall be applied to the input voltage between terminal No.3 and 1, 7 and 5, 11 and 9,15~18 and 13.

\*6:  $V_{ALM}$  shall be applied to the voltage between terminal No.2 and 1, 6 and 5, 10 and 9,19 and 13.

\*7:  $I_{ALM}$  shall be applied to the input current to terminal No.2,6,10 and 19.

\*8: Immersion time  $10 \pm 1\text{sec}$ . 1time

\*9: Terminal to base, 50/60Hz sine wave 1min. All terminals should be connected together during the test.

**■ Electrical Characteristics ( $T_j=25^{\circ}\text{C}$ ,  $V_{CC}=15\text{V}$  unless otherwise specified.)**
**● Main circuit**

Item		Symbol	Conditions	Min.	Typ.	Max.	Units	
Inverter	Collector Current at off signal input	$I_{CES}$	$V_{CE} = 1200\text{V}$	-	-	1.0	mA	
	Collector-Emitter saturation voltage	$V_{CE(sat)}$	$I_C = 25\text{A}$	Terminal	-	-	2.20	V
				Chip	-	1.7	-	V
Forward voltage of FWD	$V_F$	$I_F = 25\text{A}$	Terminal	-	-	2.65	V	
			Chip	-	2.1	-	V	
Brake	Collector Current at off signal input	$I_{CES}$	$V_{CE} =$	-	-	-	mA	
	Collector-Emitter saturation voltage	$V_{CE(sat)}$	$I_C =$	Terminal	-	-	-	V
				Chip	-	-	-	V
Forward voltage of FWD	$V_F$	$I_F =$	Terminal	-	-	-	V	
			Chip	-	-	-	V	
Switching time	$t_{on}$		$V_{DC} = 600\text{V}$ , $T_j=125^{\circ}\text{C}$	1.1	-	-	$\mu\text{s}$	
	$t_{off}$		$I_C = 25\text{A}$	-	-	2.1	$\mu\text{s}$	
	$t_{rr}$		$V_{DC} = 600\text{V}$ $I_F = 25\text{A}$	-	-	0.3	$\mu\text{s}$	

# 6MBP25VFN120-50

IGBT Modules

● **Control circuit**

Item	Symbol	Conditions	Min.	Typ.	Max.	Units	
Supply current of P-side pre-driver (per one unit)	$I_{ccp}$	Switching Frequency = 0-15kHz $T_c = -20 \sim 110^\circ\text{C}$	-	-	10	mA	
Supply current of N-side pre-driver	$I_{ccn}$		-	-	30	mA	
Input signal threshold voltage	$V_{in(th)(on)}$	$V_{in-GND}$	ON	1.2	1.4	1.6	V
	$V_{in(th)(off)}$		OFF	1.5	1.7	1.9	V

● **Protection Circuit**

Item	Symbol	Conditions	Min.	Typ.	Max.	Units
Over Current Protection Level	$I_{oc}$	$T_j = 125^\circ\text{C}$ Resistance Load	50	-	-	A
			-	-	-	A
Over Current Protection Delay time	$t_{dOC}$	$T_j = 125^\circ\text{C}$	-	5	-	$\mu\text{s}$
Short Circuit Protection Delay time	$t_{sc}$	$T_j = 125^\circ\text{C}$	-	2	3	$\mu\text{s}$
IGBT Chips Over Heating Protection Temperature Level	$T_{jOH}$	Surface of IGBT Chips	150	-	-	$^\circ\text{C}$
Over Heating Protection Hysteresis	$T_{jH}$		-	20	-	$^\circ\text{C}$
Under Voltage Protection Level	$V_{UV}$		11.0	-	12.5	V
Under Voltage Protection Hysteresis	$V_H$		0.2	0.5	-	V
Alarm Signal Hold Time	$t_{ALM(OC)}$	ALM-GND $T_c = -20 \sim 110^\circ\text{C}$ $V_{cc} \geq 10\text{V}$	1.0	2.0	2.4	ms
	$t_{ALM(UV)}$		2.5	4.0	4.9	ms
	$t_{ALM(T_{jOH})}$		5.0	8.0	11.0	ms
Resistance for current limit	$R_{ALM}$		960	1265	1570	$\Omega$

■ **Thermal Characteristics ( $T_c = 25^\circ\text{C}$ )**

Item	Symbol	Min.	Typ.	Max.	Units	
Junction to Case Thermal Resistance*10	Inverter	IGBT	-	-	0.46	$^\circ\text{C/W}$
		FWD	-	-	0.8	$^\circ\text{C/W}$
	Brake	IGBT	-	-	-	$^\circ\text{C/W}$
		FWD	-	-	-	$^\circ\text{C/W}$
Case to Fin Thermal Resistance with Compound	$R_{th(c-f)}$	-	0.05	-	$^\circ\text{C/W}$	

\*10: For 1device , the measurement point of the case is just under the chip.

■ **Noise Immunity ( $V_{DC}=600\text{V}$ ,  $V_{CC}=15\text{V}$ )**

Item	Conditions	Min.	Typ.	Max.	Units
Common mode rectangular noise	Pulse width 1 $\mu\text{s}$ ,polarity $\pm$ ,10min. Judge: no over-current, no miss operating	$\pm 2.0$	-	-	kV

■ **Recommended Operating Conditions**

Item	Symbol	Min.	Typ.	Max.	Units
DC Bus Voltage	$V_{DC}$	-	-	800	V
Power Supply Voltage of Pre-Driver	$V_{CC}$	13.5	15.0	16.5	V
Switching frequency of IPM	$f_{sw}$	-	-	20	kHz
Arm shoot through blocking time for IPM's input signal	$t_{dead}$	1.0	-	-	$\mu\text{s}$
Screw Torque (M4)	-	1.3	-	1.7	Nm

# 6MBP25VFN120-50

IGBT Modules

## ■ Block Diagram

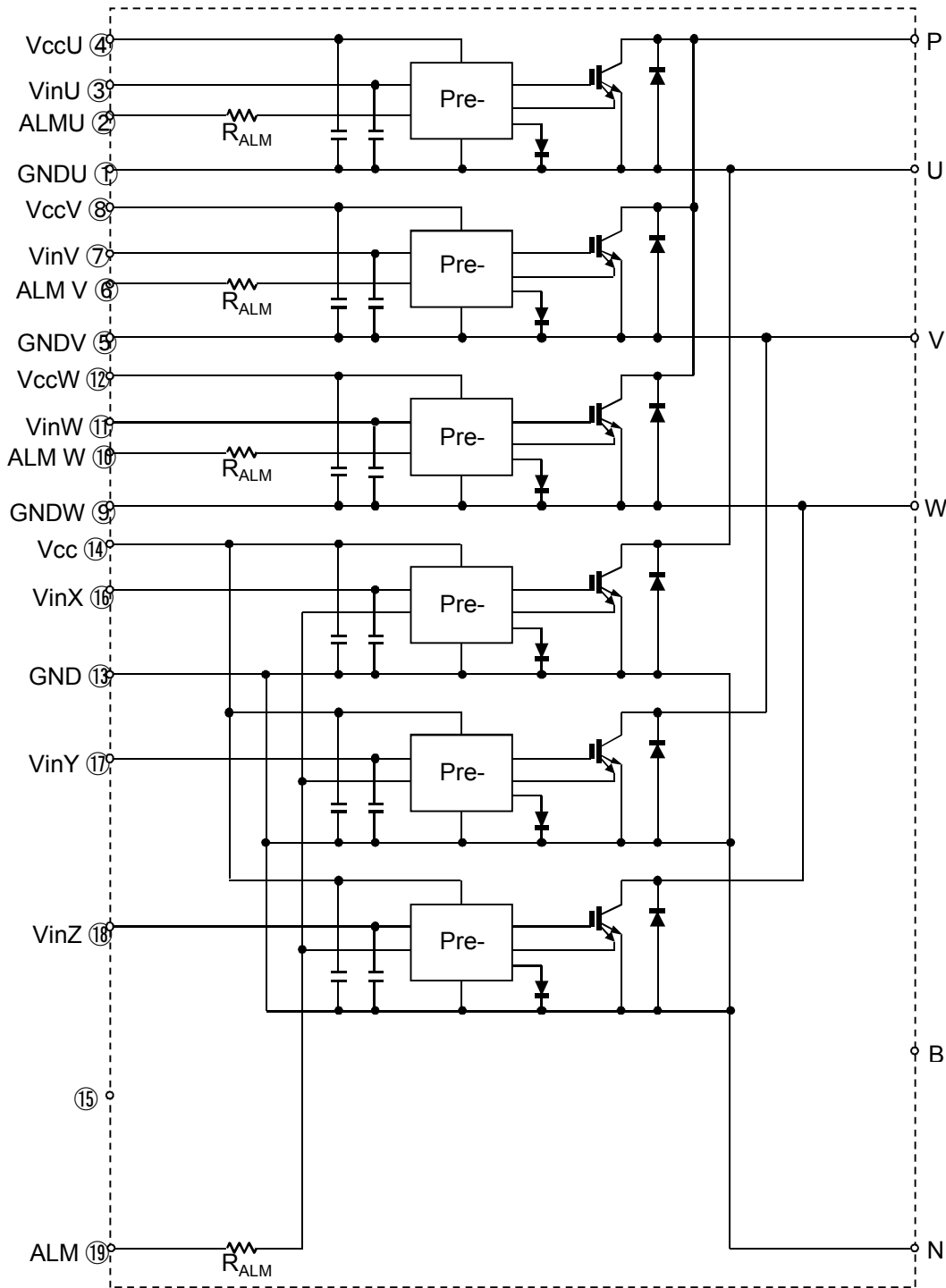

Pre-drivers include following functions

1. Amplifier for driver
2. Short circuit protection
3. Under voltage lockout circuit
4. Over current protection
5. IGBT chip over heating protection

# 6MBP25VFN120-50

IGBT Modules

■ Characteristics (Representative)  
● Control Circuit

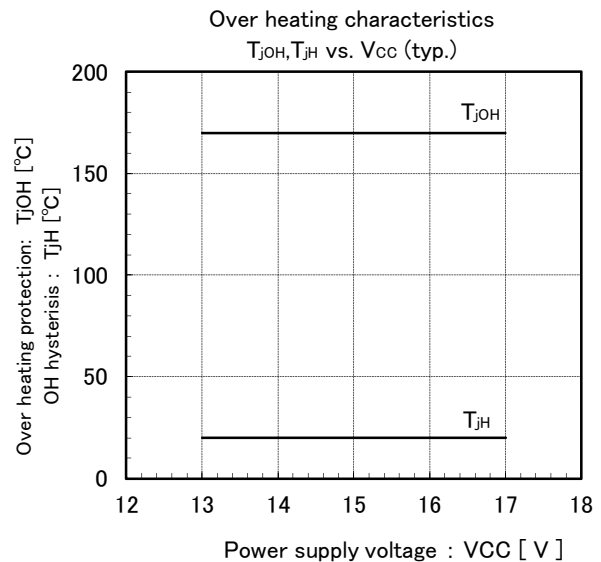
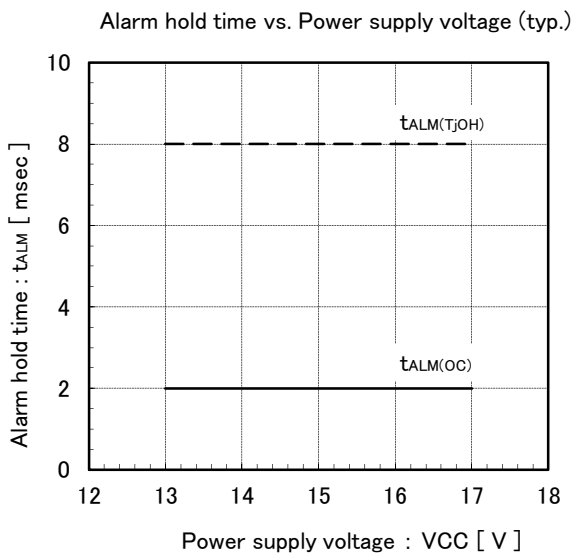
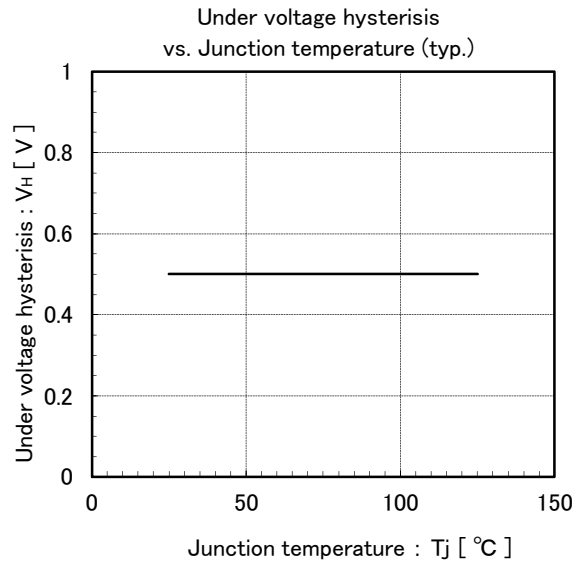
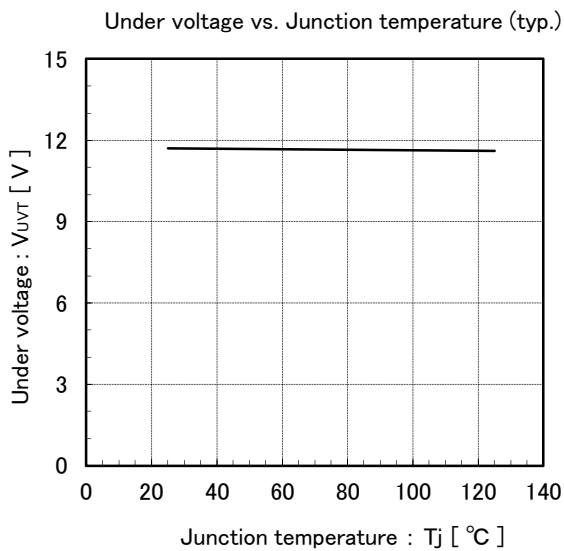
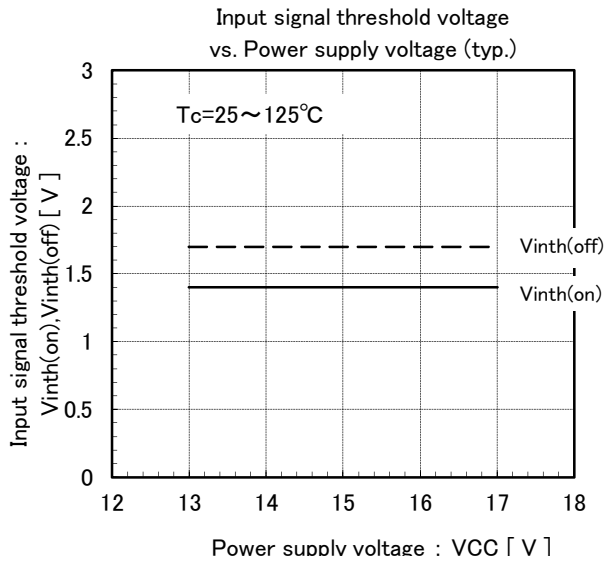
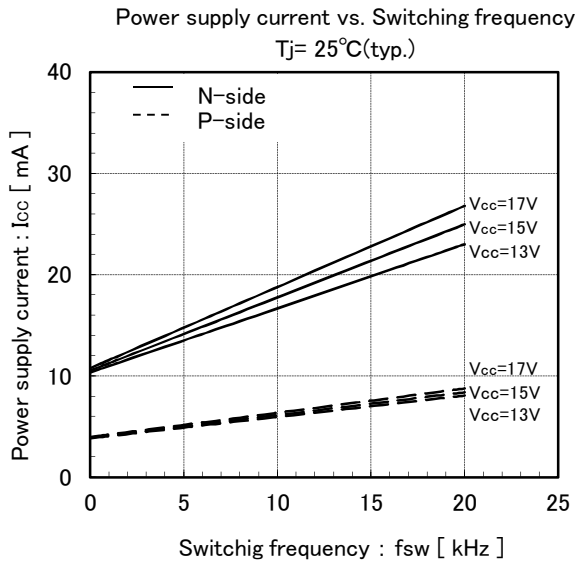

# 6MBP25VFN120-50

IGBT Modules

● Inverter

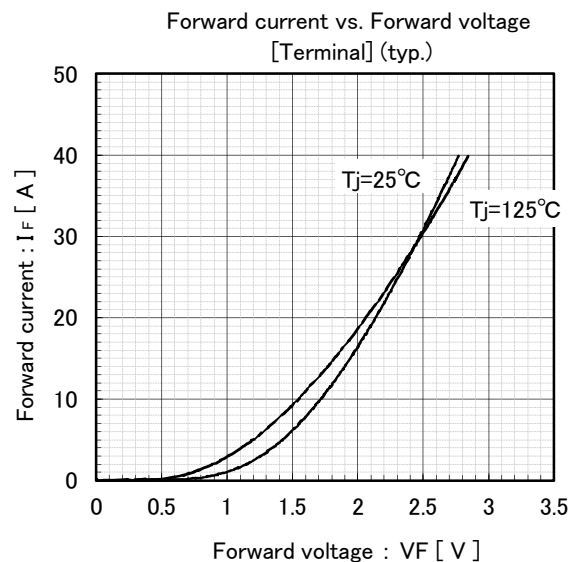
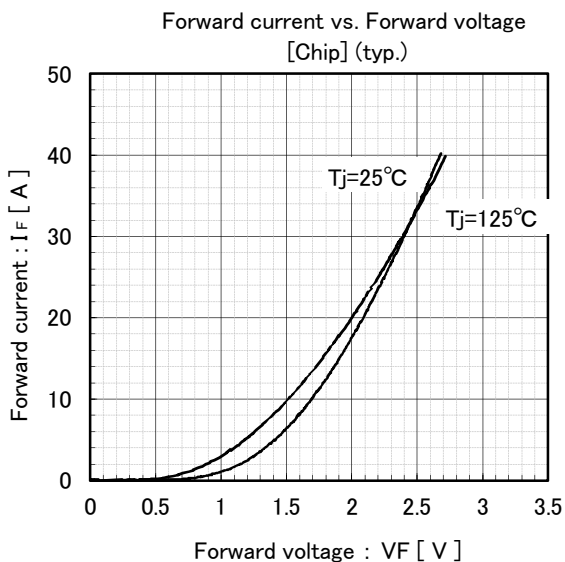
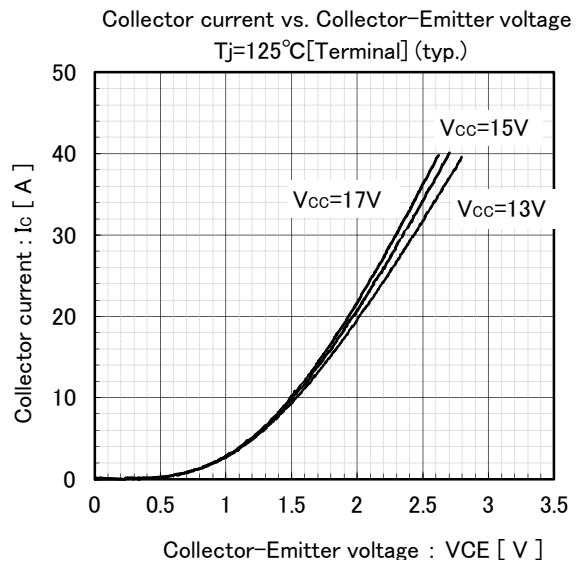
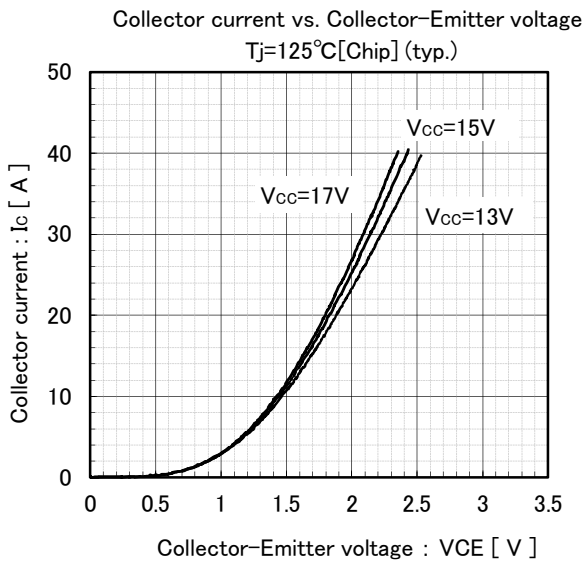
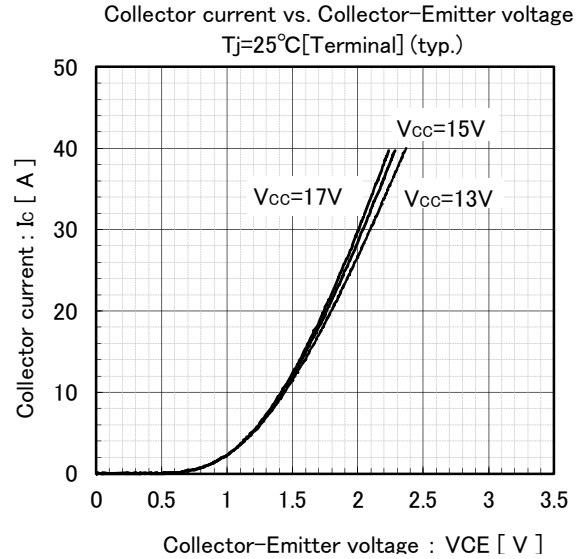
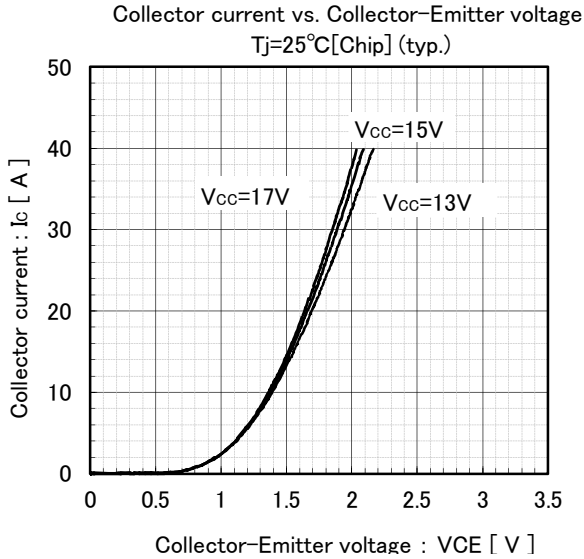

# 6MBP25VFN120-50

IGBT Modules

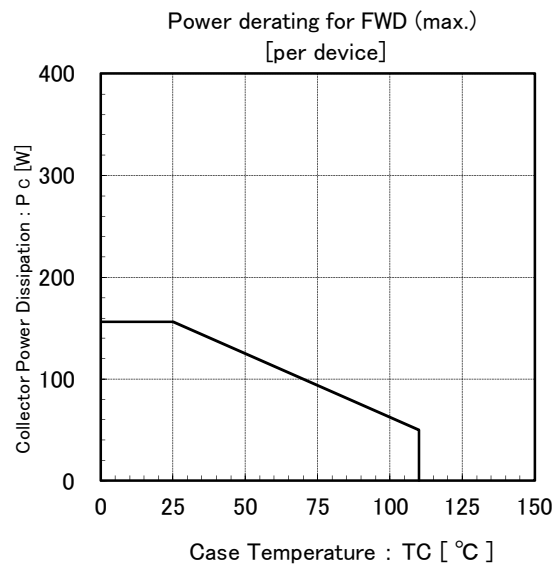
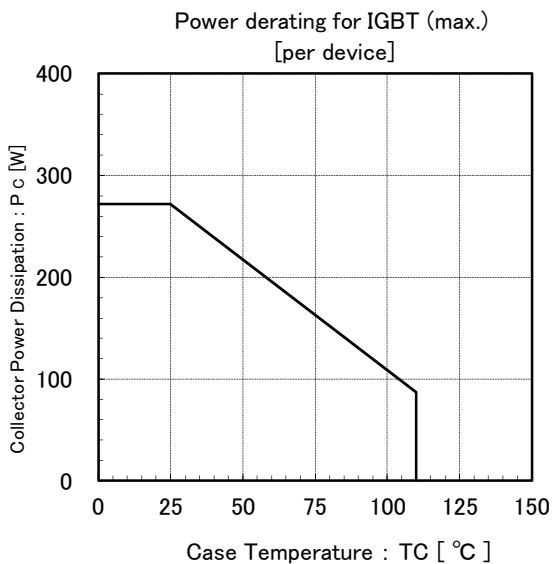
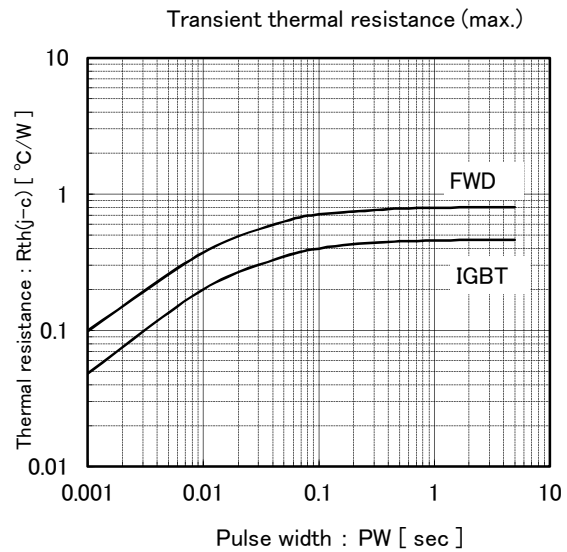
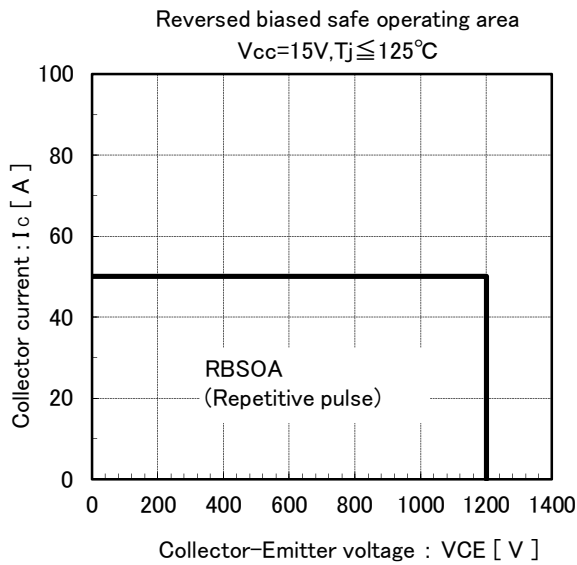
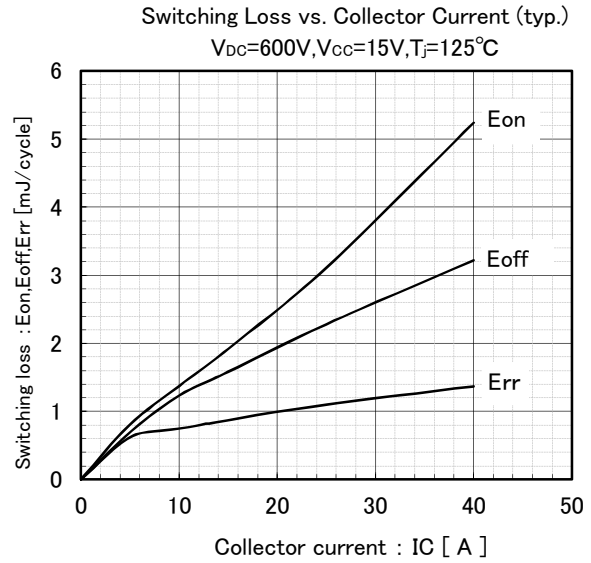
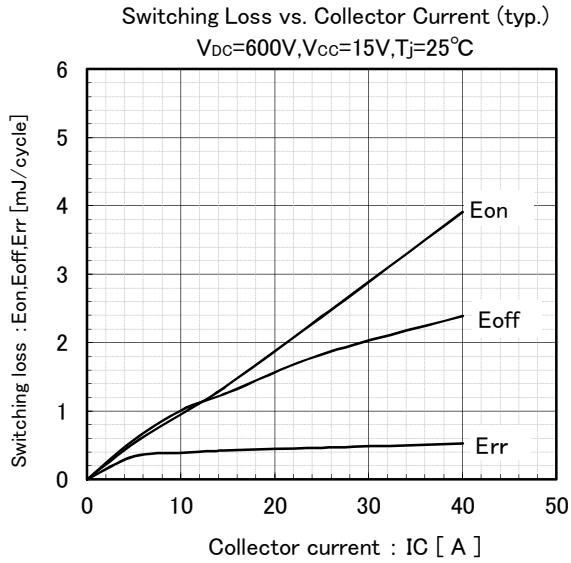

# 6MBP25VFN120-50

IGBT Modules

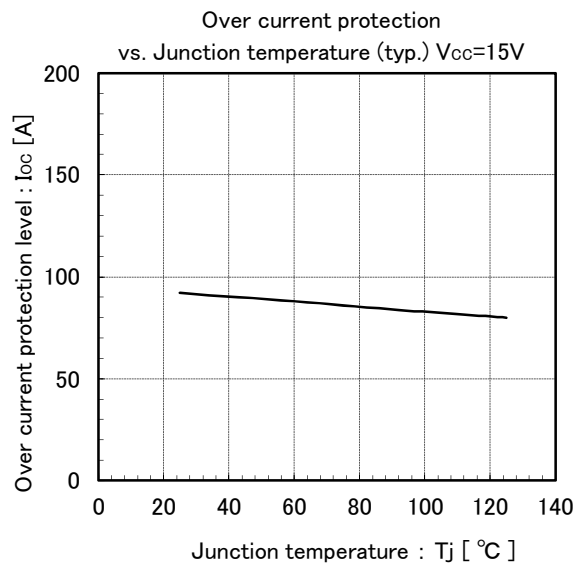
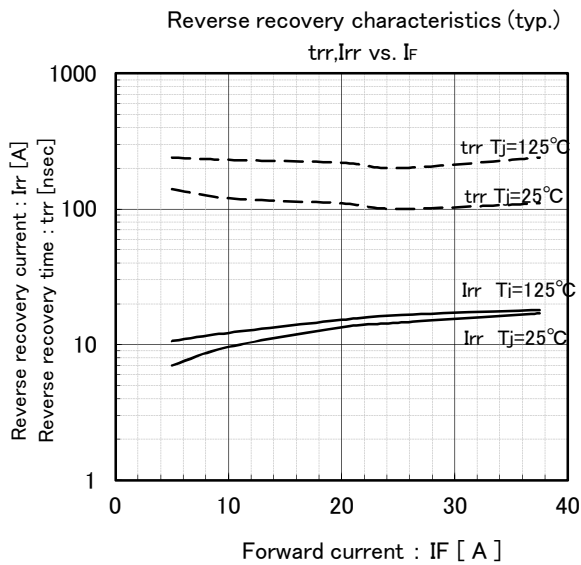
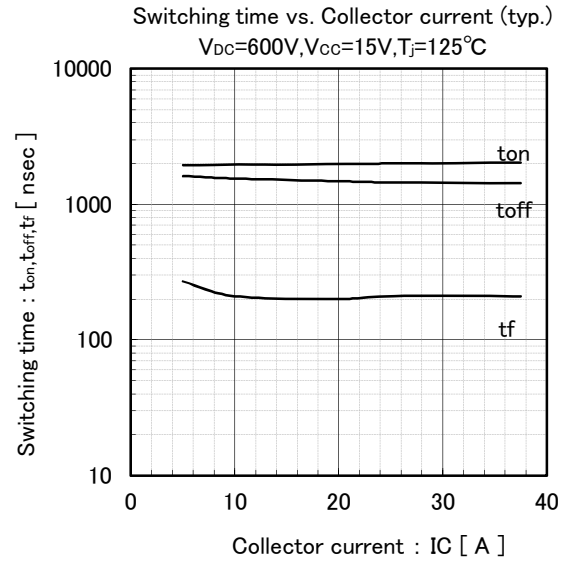
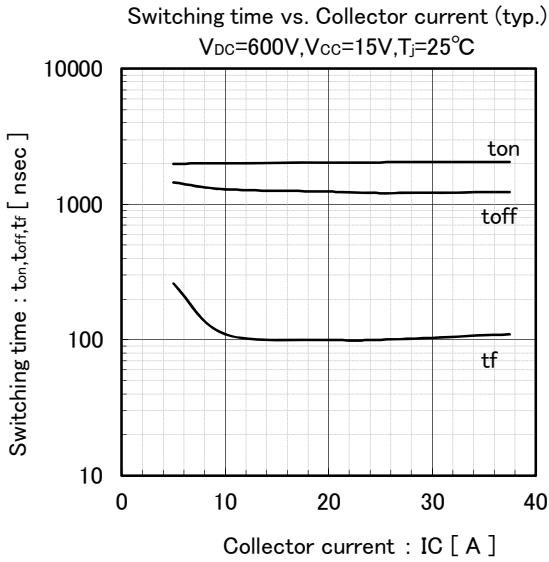



## Warnings

1. This Catalog contains the product specifications, characteristics, data, materials, and structures as of 3/2015. The contents are subject to change without notice for specification changes or other reasons. When using a product listed in this Catalog, be sure to obtain the latest specifications.
2. All applications described in this Catalog exemplify the use of Fuji's products for your reference only. No right or license, either express or implied, under any patent, copyright, trade secret or other intellectual property right owned by Fuji Electric Co., Ltd. is (or shall be deemed) granted. Fuji Electric Co., Ltd. makes no representation or warranty, whether express or implied, relating to the infringement or alleged infringement of other's intellectual property rights which may arise from the use of the applications described herein.
3. Although Fuji Electric Co., Ltd. is enhancing product quality and reliability, a small percentage of semiconductor products may become faulty. When using Fuji Electric semiconductor products in your equipment, you are requested to take adequate safety measures to prevent the equipment from causing a physical injury, fire, or other problem if any of the products become faulty. It is recommended to make your design fail-safe, flame retardant, and free of malfunction.
4. The products introduced in this Catalog are intended for use in the following electronic and electrical equipment which has normal reliability requirements.  
 ·Computers ·OA equipment ·Communications equipment (terminal devices) ·Measurement equipment  
 ·Machine tools ·Audiovisual equipment ·Electrical home appliances ·Personal equipment ·Industrial robots etc.
5. If you need to use a product in this Catalog for equipment requiring higher reliability than normal, such as for the equipment listed below, it is imperative to contact Fuji Electric Co., Ltd. to obtain prior approval. When using these products for such equipment, take adequate measures such as a backup system to prevent the equipment from malfunctioning even if a Fuji's product incorporated in the equipment becomes faulty.  
 ·Transportation equipment (mounted on cars and ships) ·Trunk communications equipment  
 ·Traffic-signal control equipment ·Gas leakage detectors with an auto-shut-off feature  
 ·Emergency equipment for responding to disasters and anti-burglary devices ·Safety devices ·Medical equipment
6. Do not use products in this Catalog for the equipment requiring strict reliability such as the following and equivalents to strategic equipment (without limitation).  
 ·Space equipment ·Aeronautic equipment ·Nuclear control equipment ·Submarine repeater equipment
7. Copyright (c)1996-2015 by Fuji Electric Co., Ltd. All rights reserved.  
 No part of this Catalog may be reproduced in any form or by any means without the express permission of Fuji Electric Co., Ltd.
8. If you have any question about any portion in this Catalog, ask Fuji Electric Co., Ltd. or its sales agents before using the product. Neither Fuji Electric Co., Ltd. nor its agents shall be liable for any injury caused by any use of the products not in accordance with instructions set forth herein.

# Technical Information

**IGBT Modules**

- Please refer to URLs below for further information about products, application manuals and technical documents.
- 关于本规格书中没有记载的产品信息·应用手册·技术资料等·请参考以下链接。
- 本データシートに記載されていない製品情報，アプリケーションマニュアル，技術資料は以下の URL をご参照下さい。

## FUJI ELECTRIC Power Semiconductor WEB site

日本	<a href="http://www.fujielectric.co.jp/products/semiconductor/">www.fujielectric.co.jp/products/semiconductor/</a>
Global	<a href="http://www.fujielectric.com/products/semiconductor/">www.fujielectric.com/products/semiconductor/</a>
中国	<a href="http://www.fujielectric.com.cn/products/semiconductor/">www.fujielectric.com.cn/products/semiconductor/</a>
Europe	<a href="http://www.fujielectric-europe.com/components/semiconductors/">www.fujielectric-europe.com/components/semiconductors/</a>
North America	<a href="http://www.americas.fujielectric.com/components/semiconductors/">www.americas.fujielectric.com/components/semiconductors/</a>

## Information

### 日本

1 半導体総合カタログ	<a href="http://www.fujielectric.co.jp/products/semiconductor/catalog/">www.fujielectric.co.jp/products/semiconductor/catalog/</a>
2 製品情報	<a href="http://www.fujielectric.co.jp/products/semiconductor/model/">www.fujielectric.co.jp/products/semiconductor/model/</a>
3 アプリケーションマニュアル	<a href="http://www.fujielectric.co.jp/products/semiconductor/model/igbt/application/">www.fujielectric.co.jp/products/semiconductor/model/igbt/application/</a>
4 技術資料	<a href="http://www.fujielectric.co.jp/products/semiconductor/model/igbt/technical/">www.fujielectric.co.jp/products/semiconductor/model/igbt/technical/</a>
5 マウンティングインストラクション	<a href="http://www.fujielectric.co.jp/products/semiconductor/model/igbt/mounting/">www.fujielectric.co.jp/products/semiconductor/model/igbt/mounting/</a>
6 IGBT 損失シミュレーションソフト	<a href="http://www.fujielectric.co.jp/products/semiconductor/model/igbt/simulation/">www.fujielectric.co.jp/products/semiconductor/model/igbt/simulation/</a>
7 AT-NPC 3-Level 損失シミュレーションソフト	<a href="http://www.fujielectric.co.jp/products/semiconductor/model/igbt/simulation_3level/">www.fujielectric.co.jp/products/semiconductor/model/igbt/simulation_3level/</a>
8 富士電機技報	<a href="http://www.fujielectric.co.jp/products/semiconductor/journal/">www.fujielectric.co.jp/products/semiconductor/journal/</a>
9 製品のお問い合わせ	<a href="http://www.fujielectric.co.jp/products/semiconductor/contact/">www.fujielectric.co.jp/products/semiconductor/contact/</a>
10 改廃のお知らせ	<a href="http://www.fujielectric.co.jp/products/semiconductor/discontinued/">www.fujielectric.co.jp/products/semiconductor/discontinued/</a>

### Global

1 Semiconductors General Catalog	<a href="http://www.fujielectric.com/products/semiconductor/catalog/">www.fujielectric.com/products/semiconductor/catalog/</a>
2 Product Information	<a href="http://www.fujielectric.com/products/semiconductor/model/">www.fujielectric.com/products/semiconductor/model/</a>
3 Application Manuals	<a href="http://www.fujielectric.com/products/semiconductor/model/igbt/application/">www.fujielectric.com/products/semiconductor/model/igbt/application/</a>
4 Technical Documents	<a href="http://www.fujielectric.com/products/semiconductor/model/igbt/technical/">www.fujielectric.com/products/semiconductor/model/igbt/technical/</a>
5 Mounting Instructions	<a href="http://www.fujielectric.com/products/semiconductor/model/igbt/mounting/">www.fujielectric.com/products/semiconductor/model/igbt/mounting/</a>
6 IGBT Loss Simulation Software	<a href="http://www.fujielectric.com/products/semiconductor/model/igbt/simulation/">www.fujielectric.com/products/semiconductor/model/igbt/simulation/</a>
7 AT-NPC 3-Level Loss Simulation Software	<a href="http://www.fujielectric.com/products/semiconductor/model/igbt/simulation_3level/">www.fujielectric.com/products/semiconductor/model/igbt/simulation_3level/</a>
8 Fuji Electric Journal	<a href="http://www.fujielectric.com/products/semiconductor/journal/">www.fujielectric.com/products/semiconductor/journal/</a>
9 Contact	<a href="http://www.fujielectric.com/products/semiconductor/contact/">www.fujielectric.com/products/semiconductor/contact/</a>
10 Revised and discontinued product information	<a href="http://www.fujielectric.com/products/semiconductor/discontinued/">www.fujielectric.com/products/semiconductor/discontinued/</a>

### 中国

1 半导体综合目录	<a href="http://www.fujielectric.com.cn/products/semiconductor/catalog/">www.fujielectric.com.cn/products/semiconductor/catalog/</a>
2 产品信息	<a href="http://www.fujielectric.com.cn/products/semiconductor/model/">www.fujielectric.com.cn/products/semiconductor/model/</a>
3 应用手册	<a href="http://www.fujielectric.com.cn/products/semiconductor/model/igbt/application/">www.fujielectric.com.cn/products/semiconductor/model/igbt/application/</a>
4 技术资料	<a href="http://www.fujielectric.com.cn/products/semiconductor/model/igbt/technical/">www.fujielectric.com.cn/products/semiconductor/model/igbt/technical/</a>
5 安装说明书	<a href="http://www.fujielectric.com.cn/products/semiconductor/model/igbt/mounting/">www.fujielectric.com.cn/products/semiconductor/model/igbt/mounting/</a>
6 IGBT 损耗模拟软件	<a href="http://www.fujielectric.com.cn/products/semiconductor/model/igbt/simulation/">www.fujielectric.com.cn/products/semiconductor/model/igbt/simulation/</a>
7 AT-NPC 3-Level 损耗模拟软件	<a href="http://www.fujielectric.com.cn/products/semiconductor/model/igbt/simulation_3level/">www.fujielectric.com.cn/products/semiconductor/model/igbt/simulation_3level/</a>
8 富士电机技报	<a href="http://www.fujielectric.com.cn/products/semiconductor/journal/">www.fujielectric.com.cn/products/semiconductor/journal/</a>
9 产品咨询	<a href="http://www.fujielectric.com.cn/products/semiconductor/contact/">www.fujielectric.com.cn/products/semiconductor/contact/</a>
10 产品更改和停产信息	<a href="http://www.fujielectric.com.cn/products/semiconductor/discontinued/">www.fujielectric.com.cn/products/semiconductor/discontinued/</a>