

# SKiiP 24NAB126V10

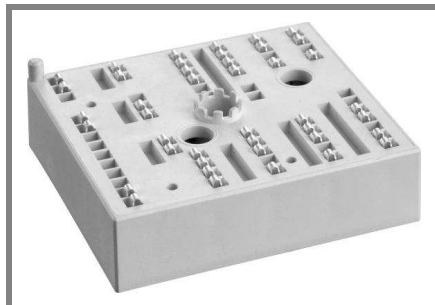

MiniSKiiP® 2

3-phase bridge rectifier +  
brake chopper + 3-phase  
bridge inverter  
SKiiP 24NAB126V10

## Features

- Fast Trench IGBTs
- Robust and soft freewheeling diodes in CAL technology
- Highly reliable spring contacts for electrical connections
- UL recognised file no. E63532

## Typical Applications\*

- Inverter up to 19 kVA
- Typical motor power 11 kW

## Remarks

- $V_{CEsat}$ ,  $V_F$  = chip level value

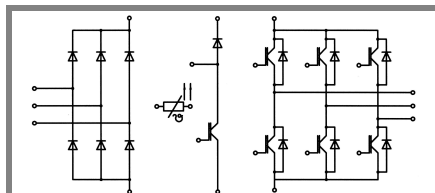

NAB

| Absolute Maximum Ratings         |                                    | $T_s = 25\text{ °C}$ , unless otherwise specified            |       |                  |
|----------------------------------|------------------------------------|--|-------|------------------|
| Symbol                           | Conditions                         | Values   | Units |                  |
| <b>IGBT - Inverter, Chopper</b>  |                                    |  |       |                  |
| $V_{CES}$                        | $T_s = 25\text{ (70) °C}$          | 1200   | V     |                  |
| $I_C$                            |                                    | 52 (40)  | A     |                  |
| $I_{CRM}$                        |                                    | 70   | A     |                  |
| $V_{GES}$                        |                                    | $\pm 20$   | V     |                  |
| $T_j$                            |                                    | - 40 ... + 150   | °C    |                  |
| <b>Diode - Inverter, Chopper</b> |                                    |  |       |                  |
| $I_F$                            | $T_s = 25\text{ (70) °C}$          | 38 (29)  | A     |                  |
| $I_{FRM}$                        |                                    | 70   | A     |                  |
| $T_j$                            |                                    | - 40 ... + 150   | °C    |                  |
| <b>Diode - Rectifier</b>         |                                    |  |       |                  |
| $V_{RRM}$                        | $T_s = 70\text{ °C}$               | 1600   | V     |                  |
| $I_F$                            |                                    | 61   | A     |                  |
| $I_{FSM}$                        |                                    | $t_p = 10\text{ ms, sin } 180\text{ °, } T_j = 25\text{ °C}$ | 700   | A                |
| $i^2t$                           |                                    | $t_p = 10\text{ ms, sin } 180\text{ °, } T_j = 25\text{ °C}$ | 2400  | A <sup>2</sup> s |
| $T_j$                            |                                    | - 40 ... + 150   | °C    |                  |
| <b>Module</b>                    |                                    |  |       |                  |
| $I_{RMS}$                        | per power terminal (20 A / spring) | 40   | A     |                  |
| $T_{stg}$                        |                                    | - 40 ... + 125   | °C    |                  |
| $V_{isol}$                       | AC, 1 min.                         | 2500   | V     |                  |

| Characteristics                  |   | $T_s = 25\text{ °C}$ , unless otherwise specified |            |           |       |
|----------------------------------|---|---|------------|-----------|-------|
| Symbol                           | Conditions  | min.  | typ.       | max.      | Units |
| <b>IGBT - Inverter, Chopper</b>  |   |   |            |           |       |
| $V_{CEsat}$                      | $I_{Cnom} = 35\text{ A, } T_j = 25\text{ (125) °C}$             |   | 1,7 (2)    | 2,1 (2,4) | V     |
| $V_{GE(th)}$                     | $V_{GE} = V_{CE}, I_C = 1,5\text{ mA}$                          | 5   | 5,8        | 6,5       | V     |
| $V_{CE(TO)}$                     | $T_j = 25\text{ (125) °C}$                                      |   | 1 (0,9)    | 1,2 (1,1) | V     |
| $r_T$                            | $T_j = 25\text{ (125) °C}$                                      |   | 20 (31)    | 26 (37)   | mΩ    |
| $C_{ies}$                        | $V_{CE} = 25\text{ V, } V_{GE} = 0\text{ V, } f = 1\text{ MHz}$ |   | 2,4        |           | nF    |
| $C_{oes}$                        | $V_{CE} = 25\text{ V, } V_{GE} = 0\text{ V, } f = 1\text{ MHz}$ |   | 0,5        |           | nF    |
| $C_{res}$                        | $V_{CE} = 25\text{ V, } V_{GE} = 0\text{ V, } f = 1\text{ MHz}$ |   | 0,3        |           | nF    |
| $R_{th(j-s)}$                    | per IGBT  |   | 0,75       |           | K/W   |
| $t_{d(on)}$                      | under following conditions                                      |   | 80         |           | ns    |
| $t_r$                            | $V_{CC} = 600\text{ V, } V_{GE} = \pm 15\text{ V}$              |   | 30         |           | ns    |
| $t_{d(off)}$                     | $I_{Cnom} = 35\text{ A, } T_j = 125\text{ °C}$                  |   | 410        |           | ns    |
| $t_f$                            | $R_{Gon} = R_{Goff} = 15\text{ Ω}$                              |   | 120        |           | ns    |
| $E_{on}$                         | inductive load  |   | 4,6        |           | mJ    |
| $E_{off}$                        |   |   | 4          |           | mJ    |
| <b>Diode - Inverter, Chopper</b> |   |   |            |           |       |
| $V_F = V_{EC}$                   | $I_{Fnom} = 35\text{ A, } T_j = 25\text{ (125) °C}$             |   | 1,8 (1,8)  | 2,1 (2,2) | V     |
| $V_{(TO)}$                       | $T_j = 25\text{ (125) °C}$                                      |   | 1 (0,8)    | 1,1 (0,9) | V     |
| $r_T$                            | $T_j = 25\text{ (125) °C}$                                      |   | 23 (31)    | 29 (37)   | mΩ    |
| $R_{th(j-s)}$                    | per diode   |   | 1,5        |           | K/W   |
| $I_{RRM}$                        | under following conditions                                      |   | 43         |           | A     |
| $Q_{rr}$                         | $I_{Fnom} = 35\text{ A, } V_R = 600\text{ V}$                   |   | 7          |           | μC    |
| $E_{rr}$                         | $V_{GE} = 0\text{ V, } T_j = 125\text{ °C}$                     |   | 3,3        |           | mJ    |
|                                  | $di_F/dt = 1450\text{ A/μs}$                                    |   |            |           |       |
| <b>Diode - Rectifier</b>         |   |   |            |           |       |
| $V_F$                            | $I_{Fnom} = 35\text{ A, } T_j = 25\text{ °C}$                   |   | 1,1        |           | V     |
| $V_{(TO)}$                       | $T_j = 150\text{ °C}$   |   | 0,8        |           | V     |
| $r_T$                            | $T_j = 150\text{ °C}$   |   | 11         |           | mΩ    |
| $R_{th(j-s)}$                    | per diode   |   | 0,9        |           | K/W   |
| <b>Temperature Sensor</b>        |   |   |            |           |       |
| $R_{ts}$                         | 3 %, $T_r = 25\text{ (100) °C}$                                 |   | 1000(1670) |           | Ω     |
| <b>Mechanical Data</b>           |   |   |            |           |       |
| w                                |   |   | 65         |           | g     |
| $M_s$                            | Mounting torque   | 2   |            | 2,5       | Nm    |

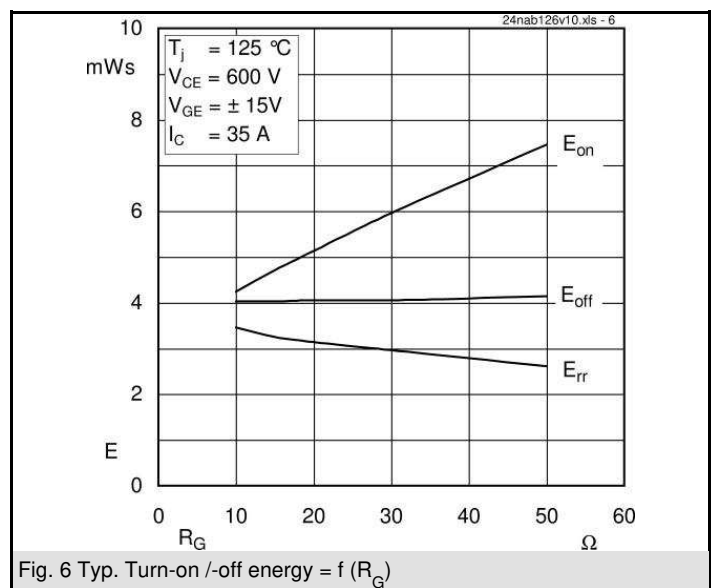
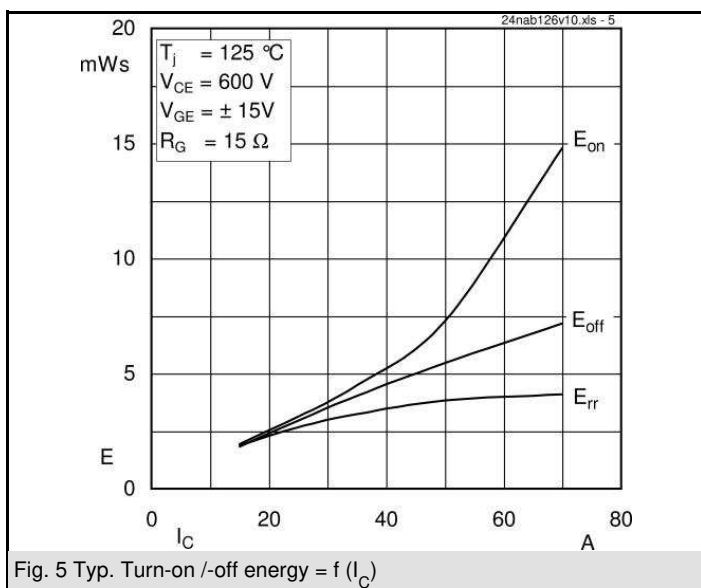
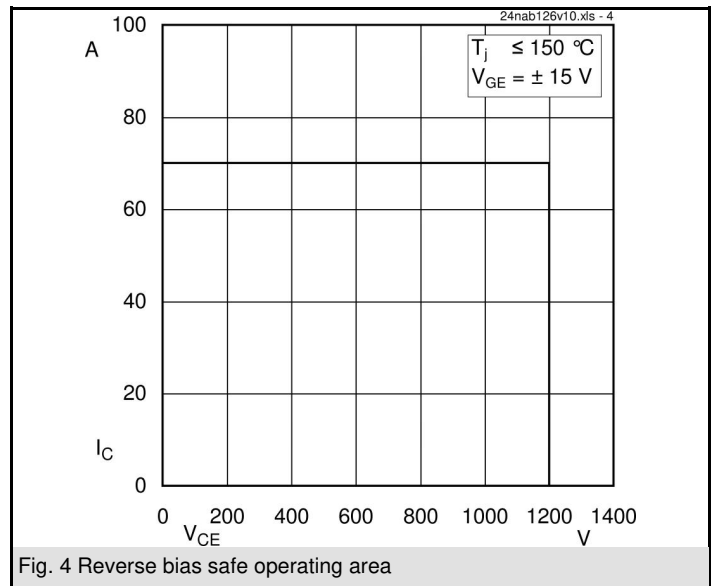
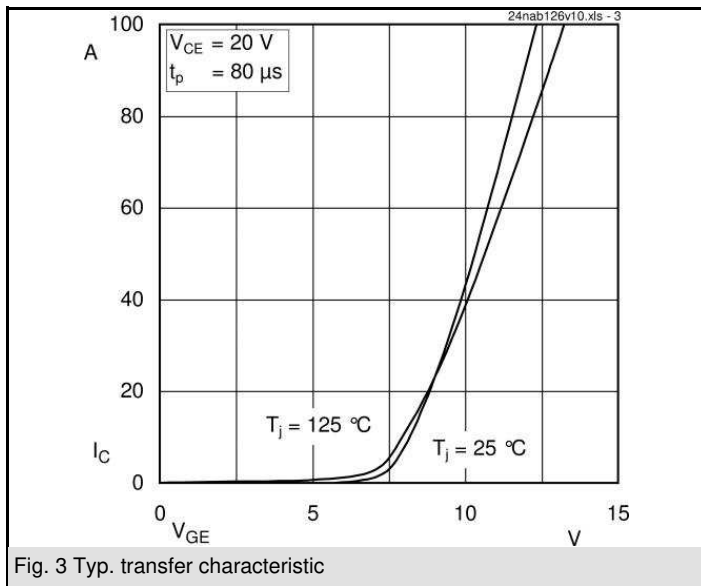
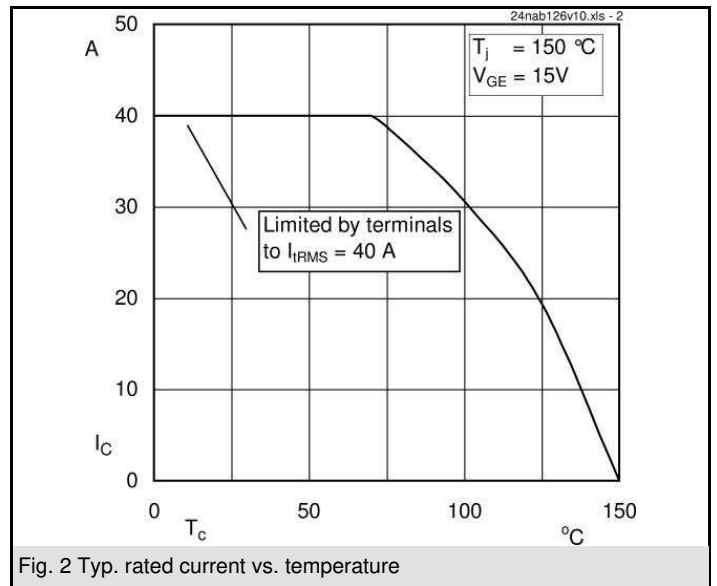
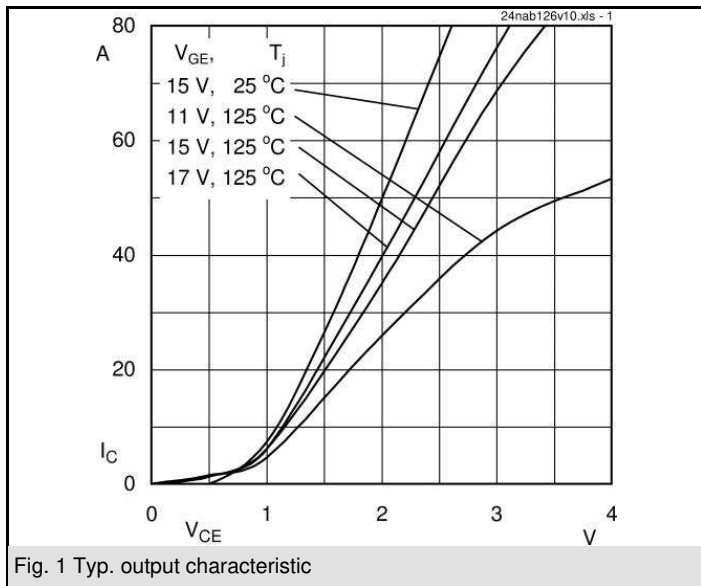

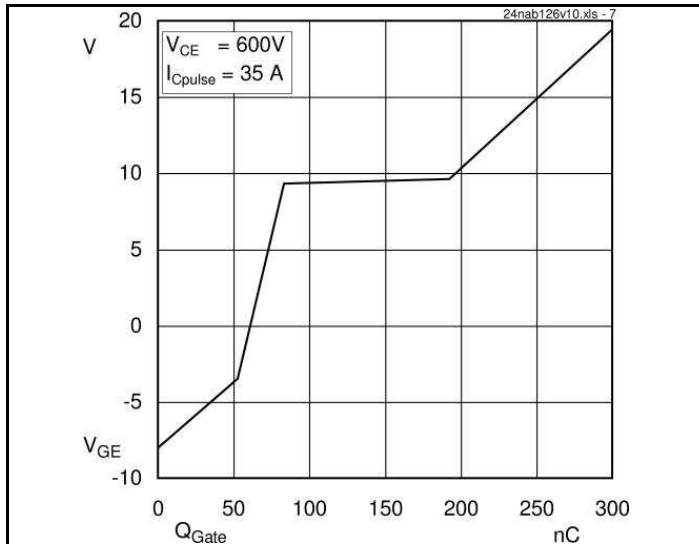

Fig. 7 Typ. gate charge characteristic

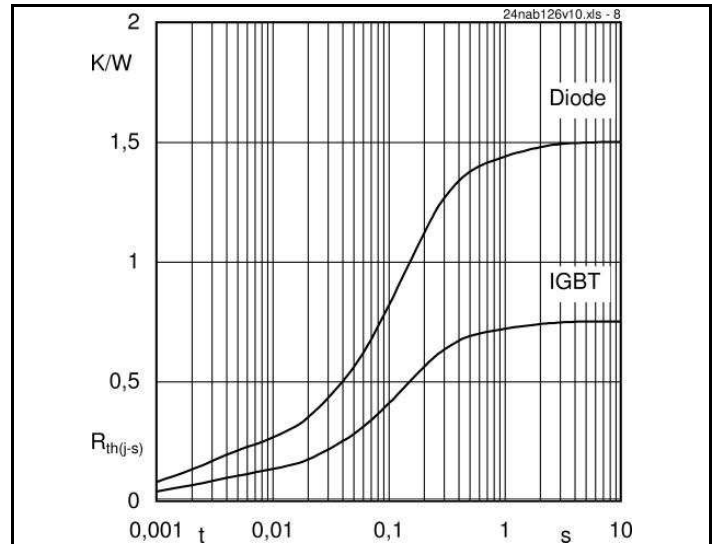

Fig. 8 Typ. thermal impedance

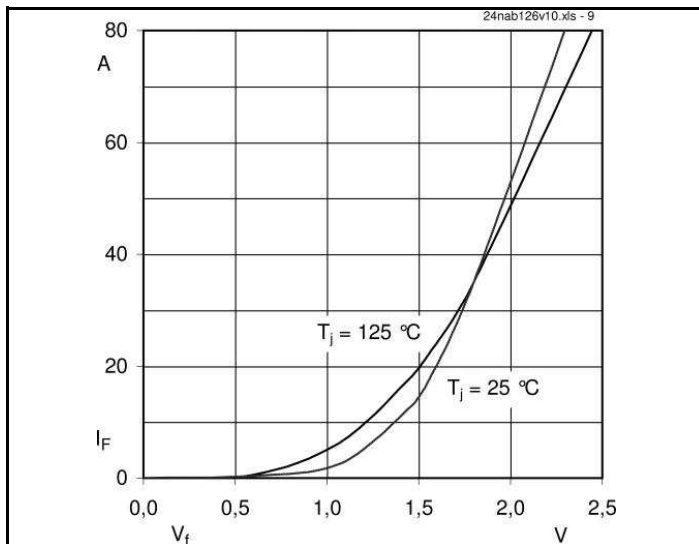

Fig. 9 Typ. freewheeling diode forward characteristic

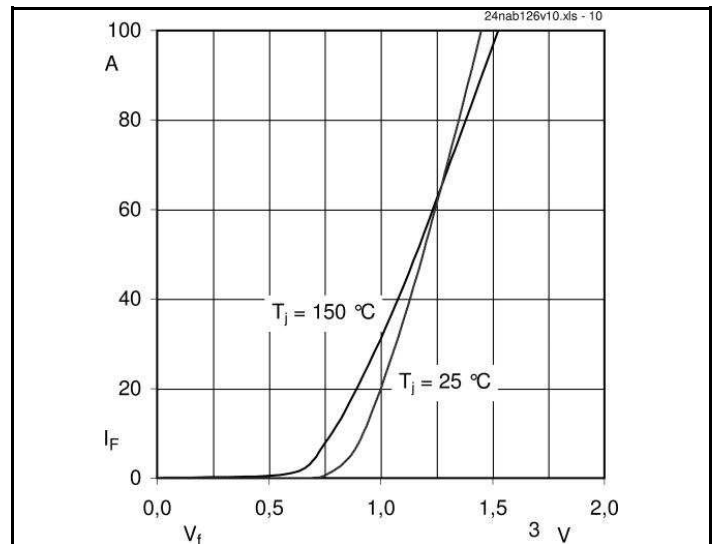
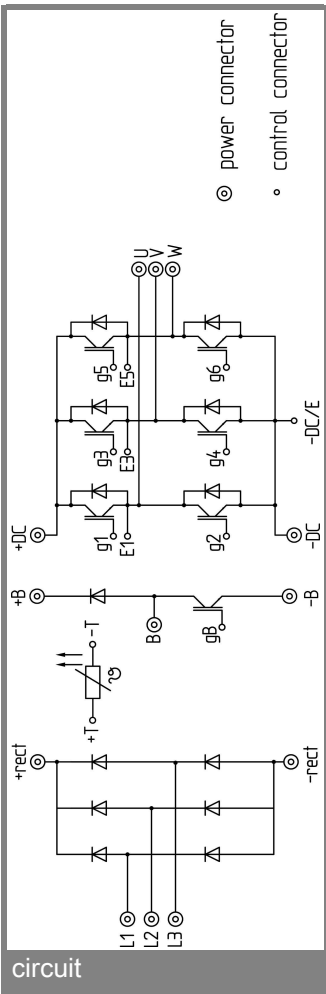
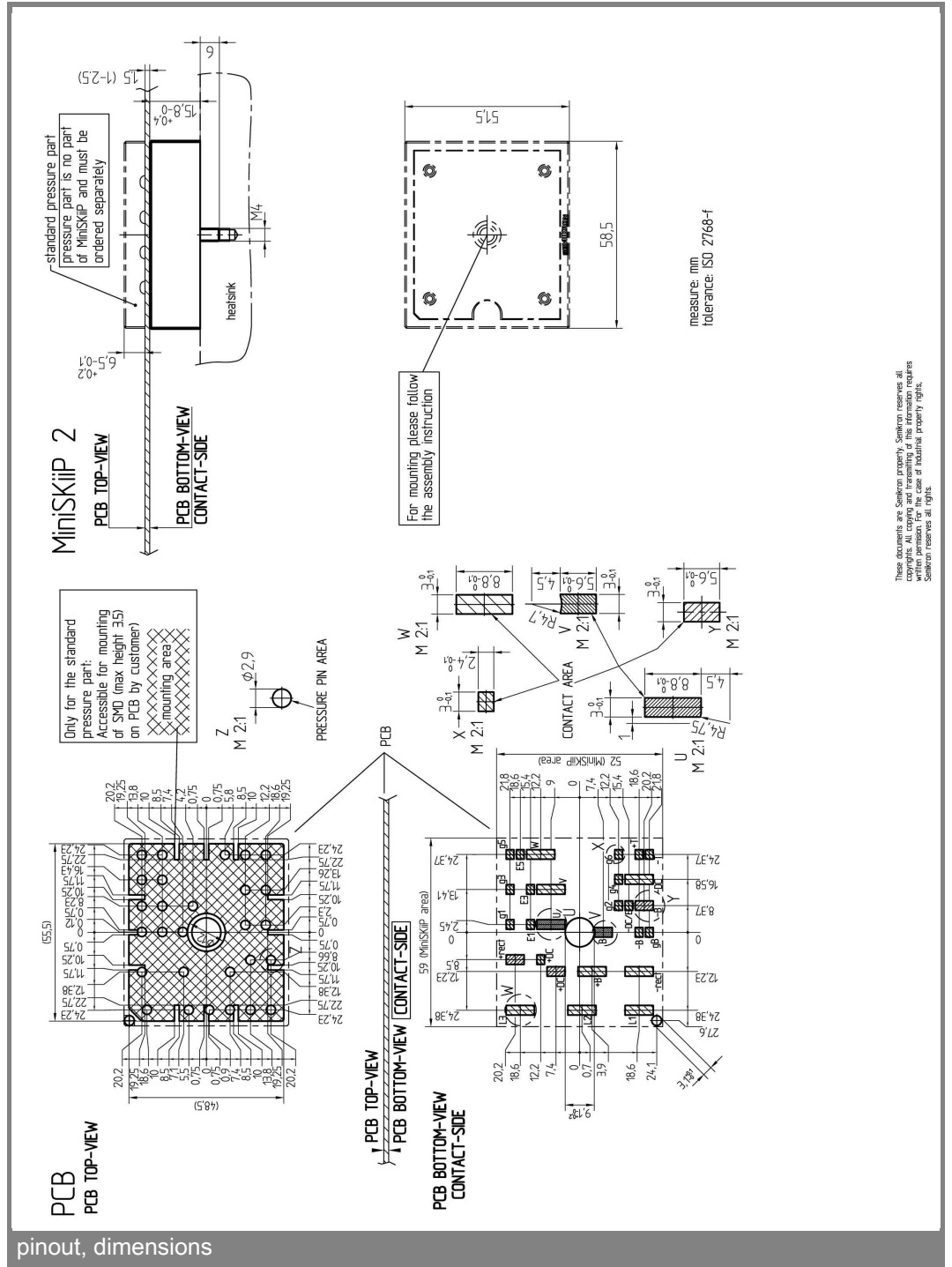

Fig. 10 Typ. input bridge forward characteristic



circuit



These documents are Semikron property. Semikron reserves all copyrights. All copying and transmitting of this information requires written permission for the case of industrial property rights. Semikron reserves all rights.

This is an electrostatic discharge sensitive device (ESDS), international standard IEC 60747-1, Chapter IX.

\* The specifications of our components may not be considered as an assurance of component characteristics. Components have to be tested for the respective application. Adjustments may be necessary. The use of SEMIKRON products in life support appliances and systems is subject to prior specification and written approval by SEMIKRON. We therefore strongly recommend prior consultation of our personal.