

SK35GD12T4ET

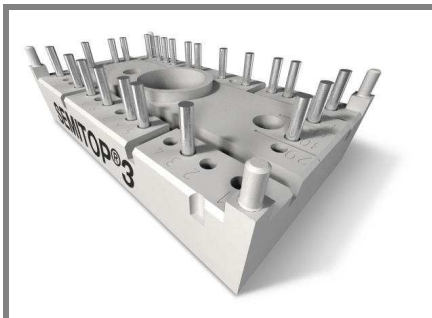

SEMITOP[®] 3

IGBT Module

SK35GD12T4ET

Features

- One screw mounting module
- Trench4 IGBT technology
- CAL4 technology FWD
- Integrated NTC temperature sensor

Typical Applications*

Remarks

- $V_{CE,sat}$, V_F = chip level value

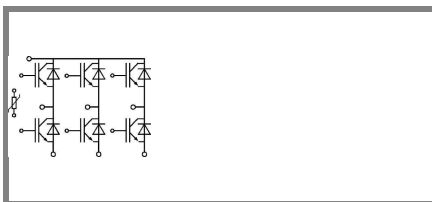

GD-ET

Absolute Maximum Ratings		$T_s = 25\text{ °C}$, unless otherwise specified		
Symbol	Conditions	Values		Units
IGBT				
V_{CES}	$T_j = 25\text{ °C}$	1200		V
I_C	$T_j = 175\text{ °C}$	$T_s = 25\text{ °C}$	44	A
		$T_s = 70\text{ °C}$	35	A
I_{CRM}	$I_{CRM} = 3 \times I_{Cnom}$	105		A
V_{GES}		± 20		V
t_{psc}	$V_{CC} = 800\text{ V}$; $V_{GE} \leq 15\text{ V}$; $T_j = 150\text{ °C}$ $V_{CES} < 1200\text{ V}$	10		µs
Inverse Diode				
I_F	$T_j = 175\text{ °C}$	$T_s = 25\text{ °C}$	40	A
		$T_s = 70\text{ °C}$	31	A
I_{FRM}	$I_{FRM} = 3 \times I_{Fnom}$	105		A
I_{FSM}	$t_p = 10\text{ ms}$; half sine wave $T_j = 150\text{ °C}$	225		A
Module				
$I_{t(RMS)}$				A
T_{vj}		-40 ... +175		°C
T_{stg}		-40 ... +125		°C
V_{isol}	AC, 1 min.	2500		V

Characteristics		$T_s = 25\text{ °C}$, unless otherwise specified				
Symbol	Conditions	min.	typ.	max.	Units	
IGBT						
$V_{GE(th)}$	$V_{GE} = V_{CE}$, $I_C = 1,2\text{ mA}$	5	5,8	6,5	V	
I_{CES}	$V_{GE} = 0\text{ V}$, $V_{CE} = V_{CES}$	$T_j = 25\text{ °C}$			1,0	mA
		$T_j = 125\text{ °C}$				mA
I_{GES}	$V_{CE} = 0\text{ V}$, $V_{GE} = 20\text{ V}$	$T_j = 25\text{ °C}$			120	nA
		$T_j = 125\text{ °C}$				nA
V_{CE0}		$T_j = 25\text{ °C}$	1,1	1,3		V
		$T_j = 150\text{ °C}$	1	1,2		V
r_{CE}	$V_{GE} = 15\text{ V}$	$T_j = 25\text{ °C}$			21,4	mΩ
		$T_j = 150\text{ °C}$			35,7	mΩ
$V_{CE(sat)}$	$I_{Cnom} = 35\text{ A}$, $V_{GE} = 15\text{ V}$	$T_j = 25\text{ °C}_{chiplev.}$	1,85	2,05		V
		$T_j = 150\text{ °C}_{chiplev.}$	2,25	2,45		V
C_{ies}	$V_{CE} = 25$, $V_{GE} = 0\text{ V}$	$f = 1\text{ MHz}$			1,95	nF
C_{oes}					0,155	nF
C_{res}					0,115	nF
Q_G	$V_{GE} = -7V...+15V$			190	nC	
$t_{d(on)}$	$R_{Gon} = 22\text{ } \Omega$	$V_{CC} = 600V$ $I_C = 35A$			28	ns
t_r					25	ns
E_{on}					3,27	mJ
$t_{d(off)}$	$R_{Goff} = 22\text{ } \Omega$ $di/dt = 2900\text{ A}/\mu s$	$T_j = 150\text{ °C}$ $V_{GE} = \pm 15\text{ V}$			303	ns
t_f					70	ns
E_{off}					3,3	mJ
$R_{th(j-s)}$	per IGBT			1,21	K/W	

SK35GD12T4ET

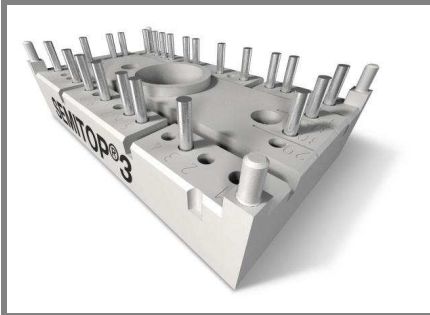

SEMITOP[®] 3

IGBT Module

SK35GD12T4ET

Features

- One screw mounting module
- Trench4 IGBT technology
- CAL4 technology FWD
- Integrated NTC temperature sensor

Typical Applications*

Remarks

- $V_{CE,sat}$, V_F = chip level value

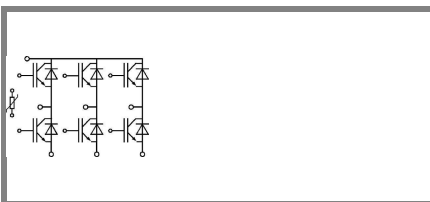

GD-ET

Characteristics			min.	typ.	max.	Units
Inverse Diode						
$V_F = V_{EC}$	$I_{Fnom} = 35 \text{ A}; V_{GE} = 0 \text{ V}$	$T_j = 25 \text{ }^\circ\text{C}_{\text{chiplev.}}$		2,3	2,62	V
		$T_j = 150 \text{ }^\circ\text{C}_{\text{chiplev.}}$		2,29	2,62	V
V_{F0}		$T_j = 25 \text{ }^\circ\text{C}$		1,3	1,5	V
		$T_j = 150 \text{ }^\circ\text{C}$		0,9	1,1	V
r_F		$T_j = 25 \text{ }^\circ\text{C}$		27	32	m Ω
		$T_j = 150 \text{ }^\circ\text{C}$		39,7	43,4	m Ω
I_{RRM}	$I_F = 35 \text{ A}$	$T_j = 150 \text{ }^\circ\text{C}$		30		A
Q_{rr}	$di/dt = 2900 \text{ A}/\mu\text{s}$			2		μC
E_{rr}	$V_{CC} = 600\text{V}$			1,46		mJ
$R_{th(j-s)D}$	per diode			1,55		K/W
M_s	to heat sink		2,25		2,5	Nm
w				30		g
Temperature sensor						
R_{100}	$T_s = 100^\circ\text{C}$ ($R_{25} = 5\text{k}\Omega$)			493 \pm 5%		Ω

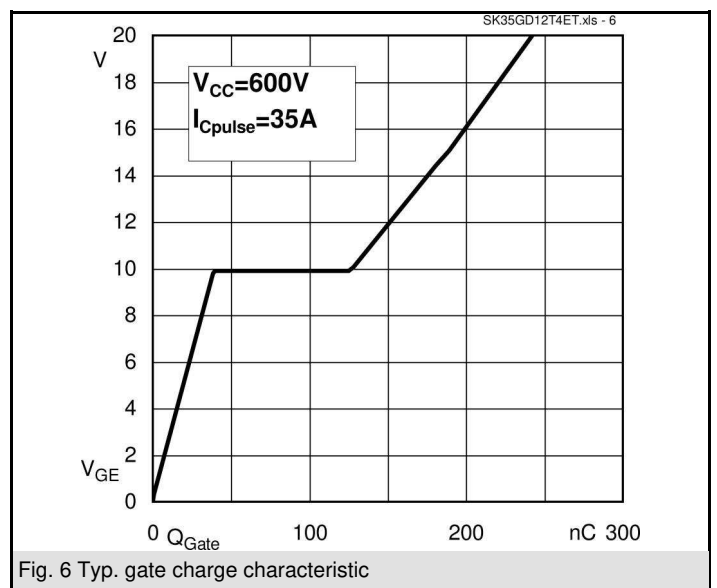
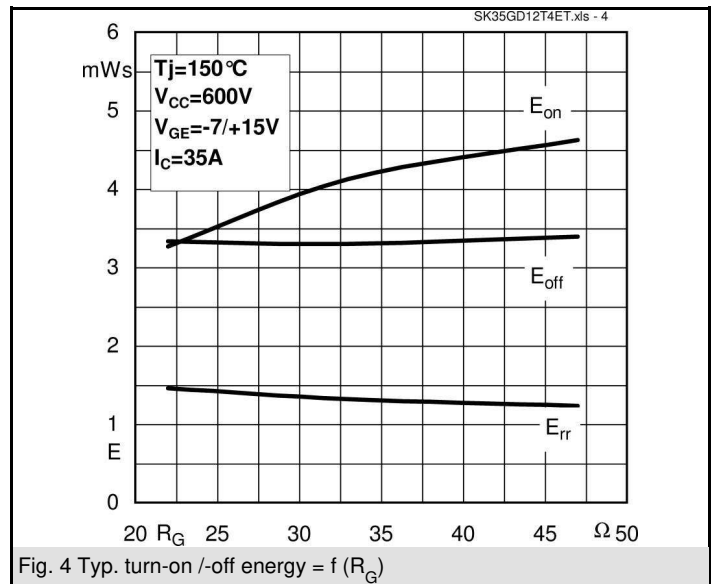
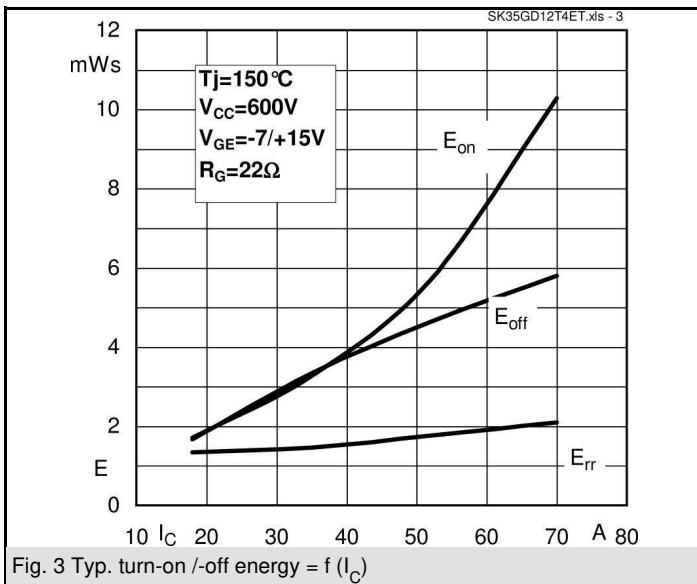
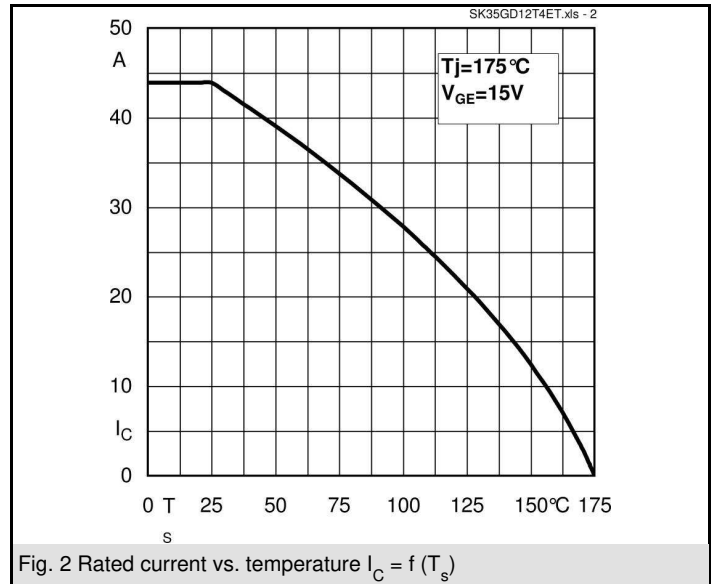
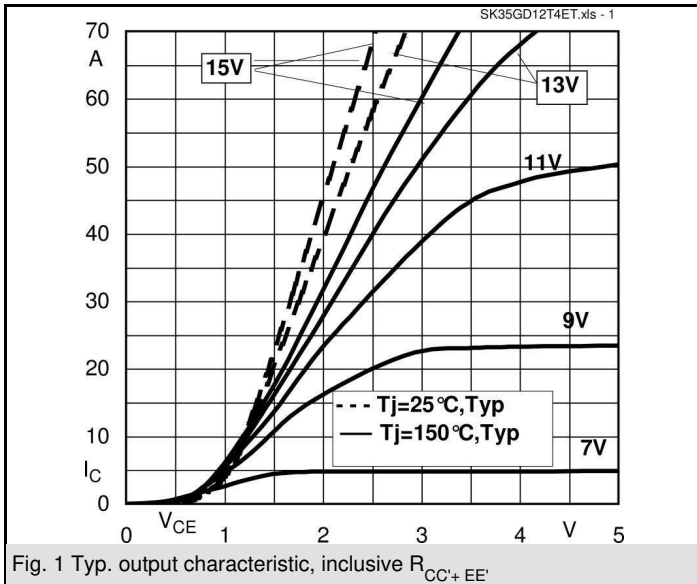

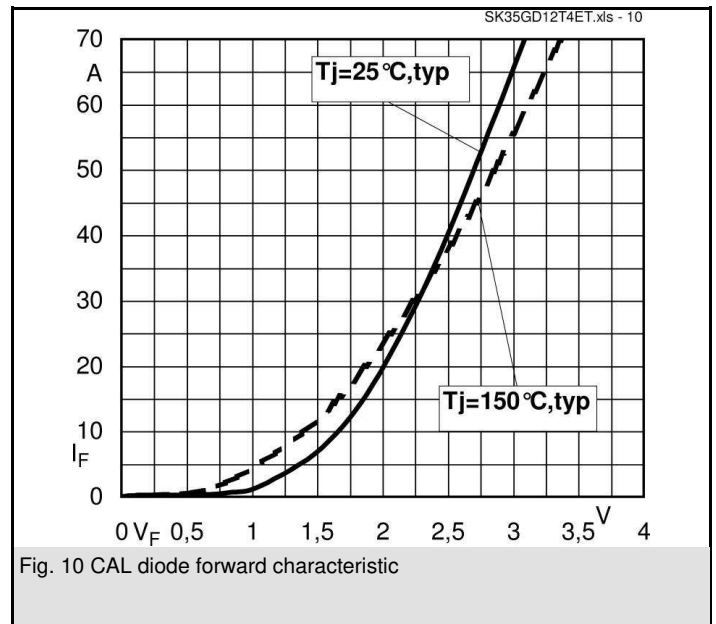
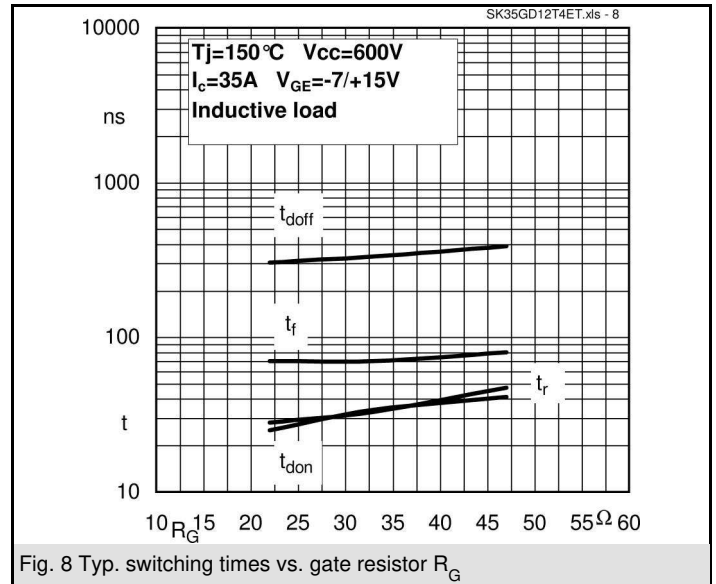
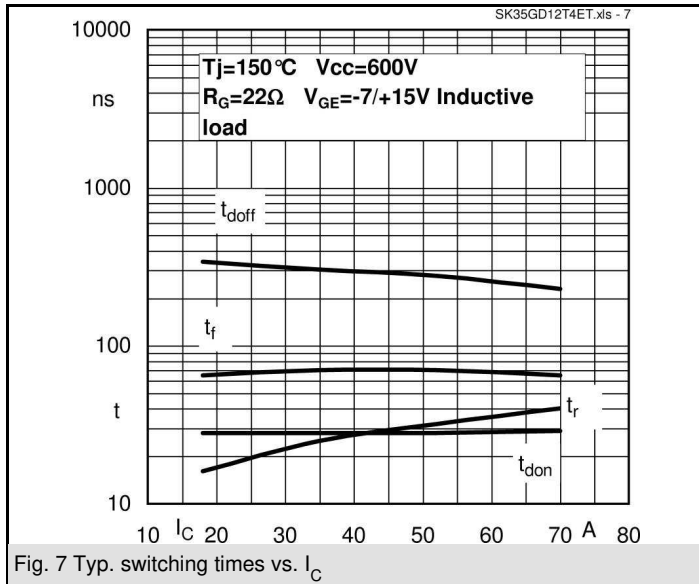

SK35GD12T4ET

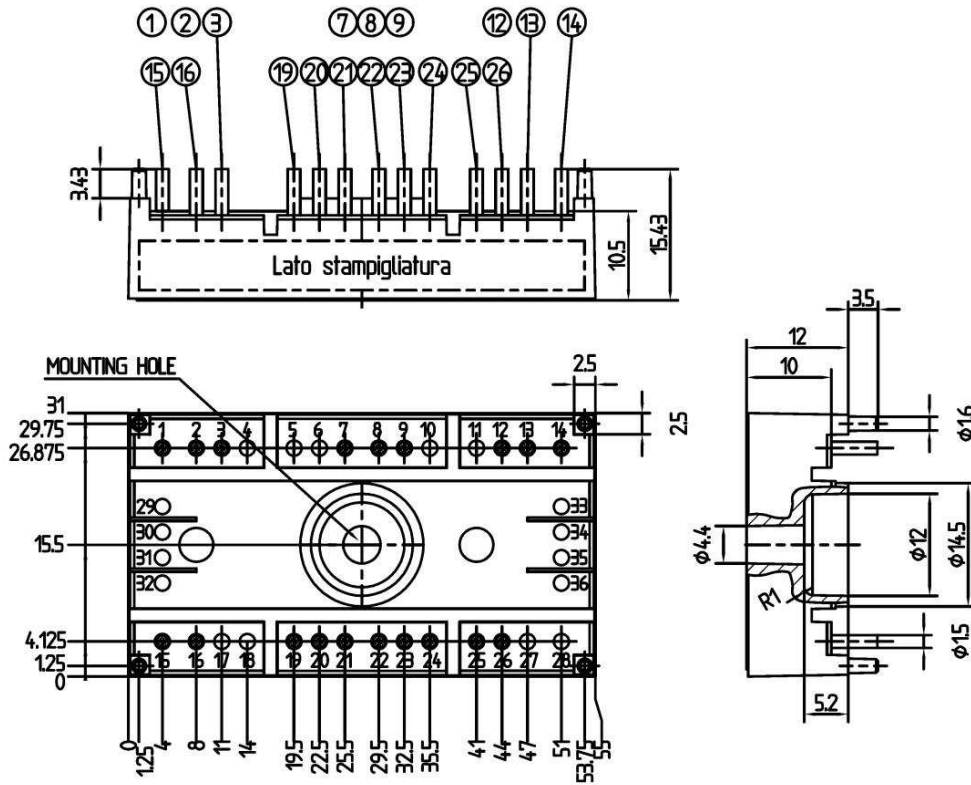

Case T52 (Suggested hole diameter for solder pins and plastic mounting pins: 2mm)

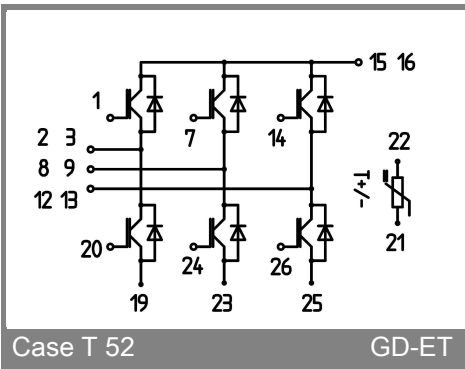

Case T 52

GD-ET

This is an electrostatic discharge sensitive device (ESDS), international standard IEC 60747-1, chapter IX.

*IMPORTANT INFORMATION AND WARNINGS

The specifications of SEMIKRON products may not be considered as guarantee or assurance of product characteristics ("Beschaffenheitsgarantie"). The specifications of SEMIKRON products describe only the usual characteristics of products to be expected in typical applications, which may still vary depending on the specific application. Therefore, products must be tested for the respective application in advance. Application adjustments may be necessary. The user of SEMIKRON products is responsible for the safety of their applications embedding SEMIKRON products and must take adequate safety measures to prevent the applications from causing a physical injury, fire or other problem if any of SEMIKRON products become faulty. The user is responsible to make sure that the application design is compliant with all applicable laws, regulations, norms and standards. Except as otherwise explicitly approved by SEMIKRON in a written document signed by authorized representatives of SEMIKRON, SEMIKRON products may not be used in any applications where a failure of the product or any consequences of the use thereof can reasonably be expected to result in personal injury. No representation or warranty is given and no liability is assumed with respect to the accuracy, completeness and/or use of any information herein, including without limitation, warranties of non-infringement of intellectual property rights of any third party. SEMIKRON does not assume any liability arising out of the applications or use of any product; neither does it convey any license under its patent rights, copyrights, trade secrets or other intellectual property rights, nor the rights of others. SEMIKRON makes no representation or warranty of non-infringement or alleged non-infringement of intellectual property rights of any third party which may arise from applications. Due to technical requirements our products may contain dangerous substances. For information on the types in question please contact the nearest SEMIKRON sales office. This document supersedes and replaces all information previously supplied and may be superseded by updates. SEMIKRON reserves the right to make changes.