

# SK30GD066ET

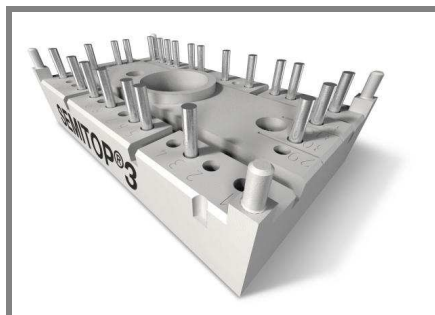

SEMITOP® 3

## IGBT Module

SK30GD066ET

### Target Data

### Features

- Compact design
- One screw mounting
- Heat transfer and isolation through direct copper bonded aluminium oxide ceramic (DCB)
- Trench IGBT technology
- CAL technology FWD
- Integrated NTC temperature sensor

### Typical Applications\*

- Inverter up to 10 kVA
- Typ. motor power 4 kW

### Remarks

- $V_{isol} = 3000V$  AC, 50Hz, 1s

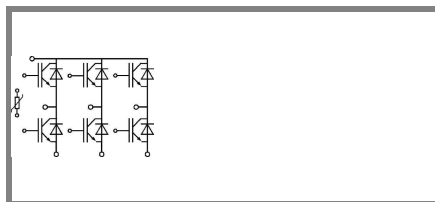

GD-ET

Absolute Maximum Ratings		$T_s = 25\text{ °C}$ , unless otherwise specified	
Symbol	Conditions	Values	Units
<b>IGBT</b>			
$V_{CES}$	$T_j = 25\text{ °C}$	600	V
$I_C$	$T_j = 175\text{ °C}$	$T_s = 25\text{ °C}$	40 A
		$T_s = 70\text{ °C}$	31 A
$I_{CRM}$	$I_{CRM} = 2 \times I_{Cnom}$	60	A
$V_{GES}$		$\pm 20$	V
$t_{psc}$	$V_{CC} = 360\text{ V}$ ; $V_{GE} \leq 20\text{ V}$ ; $T_j = 150\text{ °C}$ $V_{CES} < 600\text{ V}$	6	$\mu\text{s}$
<b>Inverse Diode</b>			
$I_F$	$T_j = 175\text{ °C}$	$T_s = 25\text{ °C}$	36 A
		$T_s = 70\text{ °C}$	28 A
$I_{FRM}$	$I_{FRM} = 2 \times I_{Fnom}$	60	A
$I_{FSM}$	$t_p = 10\text{ ms}$ ; half sine wave $T_j = 150\text{ °C}$	160	A
<b>Module</b>			
$I_{t(RMS)}$			A
$T_{vj}$		-40 ... +175	$^{\circ}\text{C}$
$T_{stg}$		-40 ... +125	$^{\circ}\text{C}$
$V_{isol}$	AC, 1 min.	2500	V

Characteristics		$T_s = 25\text{ °C}$ , unless otherwise specified			
Symbol	Conditions	min.	typ.	max.	Units
<b>IGBT</b>					
$V_{GE(th)}$	$V_{GE} = V_{CE}$ , $I_C = 0,43\text{ mA}$	5	5,8	6,5	V
$I_{CES}$	$V_{GE} = 0\text{ V}$ , $V_{CE} = V_{CES}$	$T_j = 25\text{ °C}$		0,0016	mA
		$T_j = 125\text{ °C}$			mA
$I_{GES}$	$V_{CE} = 0\text{ V}$ , $V_{GE} = 20\text{ V}$	$T_j = 25\text{ °C}$		300	nA
		$T_j = 125\text{ °C}$			nA
$V_{CE0}$		$T_j = 25\text{ °C}$	0,9	1,1	V
		$T_j = 150\text{ °C}$	0,8	1	V
$r_{CE}$	$V_{GE} = 15\text{ V}$	$T_j = 25\text{ °C}$	18,3	25	$\text{m}\Omega$
		$T_j = 150\text{ °C}$	28	35	$\text{m}\Omega$
$V_{CE(sat)}$	$I_{Cnom} = 30\text{ A}$ , $V_{GE} = 15\text{ V}$	$T_j = 25\text{ °C}_{chiplev.}$	1,45	1,85	V
		$T_j = 125\text{ °C}_{chiplev.}$	1,65	2,05	V
$C_{ies}$	$V_{CE} = 25$ , $V_{GE} = 0\text{ V}$	$f = 1\text{ MHz}$	1,63		nF
$C_{oes}$			0,11		nF
$C_{res}$			0,05		nF
$Q_G$	$V_{GE} = -7V...+15V$		275		nC
$t_{d(on)}$	$R_{Gon} = 25\ \Omega$ $di/dt = 2335\text{ A}/\mu\text{s}$	$V_{CC} = 300V$ $I_C = 30A$	24		ns
$t_r$			27		ns
$E_{on}$			0,97		mJ
$t_{d(off)}$	$R_{Goff} = 25\ \Omega$ $di/dt = 2335\text{ A}/\mu\text{s}$	$T_j = 150\text{ °C}$ $V_{GE} = -7/+15V$	328		ns
$t_f$			54		ns
$E_{off}$			1,77		mJ
$R_{th(j-s)}$	per IGBT		1,65		K/W

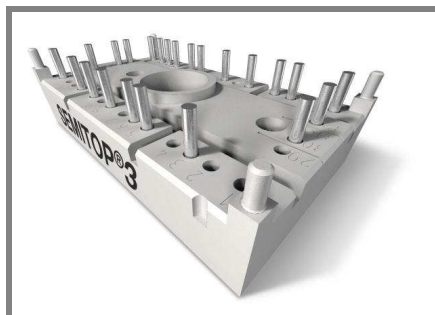

**SEMITOP<sup>®</sup> 3**

## IGBT Module

**SK30GD066ET**

Target Data

### Features

- Compact design
- One screw mounting
- Heat transfer and isolation through direct copper bonded aluminium oxide ceramic (DCB)
- Trench IGBT technology
- CAL technology FWD
- Integrated NTC temperature sensor

### Typical Applications\*

- Inverter up to 10 kVA
- Typ. motor power 4 kW

### Remarks

- $V_{isol} = 3000V$  AC, 50Hz, 1s

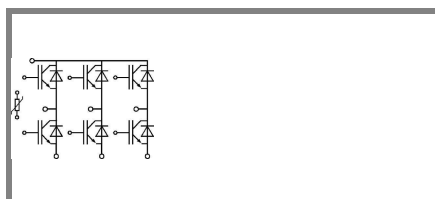

**GD-ET**

Characteristics			min.	typ.	max.	Units
Symbol	Conditions					
<b>Inverse Diode</b>						
$V_F = V_{EC}$	$I_{Fnom} = 30 A; V_{GE} = 0 V$	$T_j = 25 ^\circ C_{chiplev.}$		1,45	1,7	V
		$T_j = 150 ^\circ C_{chiplev.}$		1,45	1,7	V
$V_{F0}$		$T_j = 25 ^\circ C$		1	1,1	V
		$T_j = 150 ^\circ C$		0,9	1	V
$r_F$		$T_j = 25 ^\circ C$		15	20	m $\Omega$
		$T_j = 150 ^\circ C$		18	23,3	m $\Omega$
$I_{RRM}$	$I_F = 30 A$	$T_j = 150 ^\circ C$		30		A
$Q_{rr}$	$di/dt = 2335 A/\mu s$			1,6		$\mu C$
$E_{rr}$	$V_{CC} = 300V$			0,26		mJ
$R_{th(j-s)D}$	per diode			2,1		K/W
$M_s$	to heat sink		2,25		2,5	Nm
w				30		g
<b>Temperature sensor</b>						
$R_{100}$	$T_s = 100^\circ C (R_{25} = 5k\Omega)$			493 $\pm$ 5%		$\Omega$

This is an electrostatic discharge sensitive device (ESDS), international standard IEC 60747-1, Chapter IX.

\* The specifications of our components may not be considered as an assurance of component characteristics. Components have to be tested for the respective application. Adjustments may be necessary. The use of SEMIKRON products in life support appliances and systems is subject to prior specification and written approval by SEMIKRON. We therefore strongly recommend prior consultation of our personal.

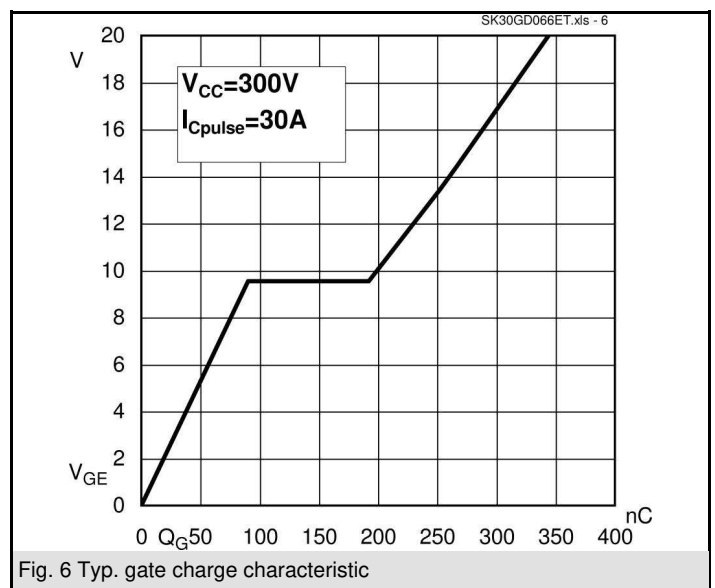
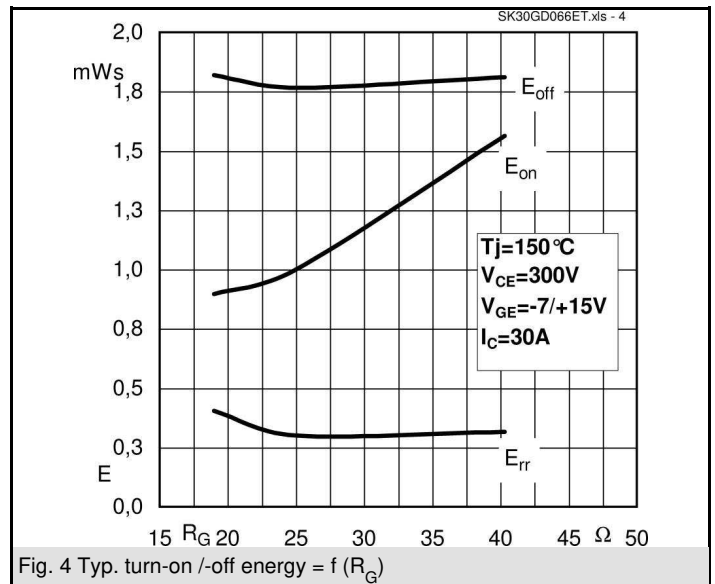
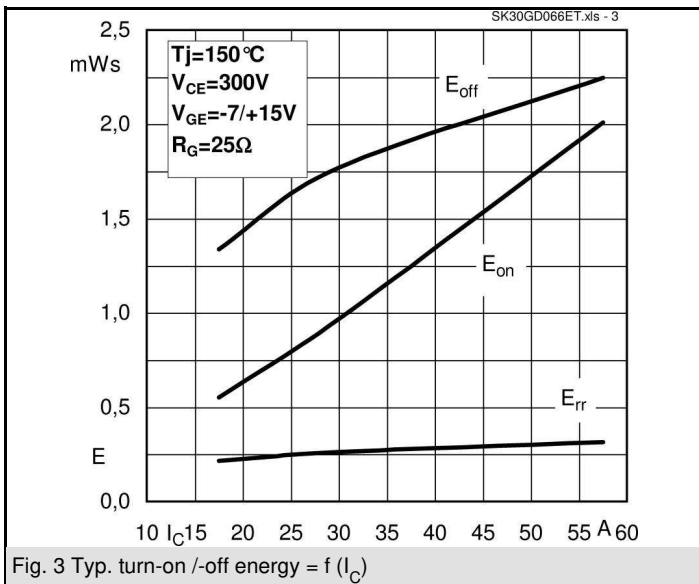
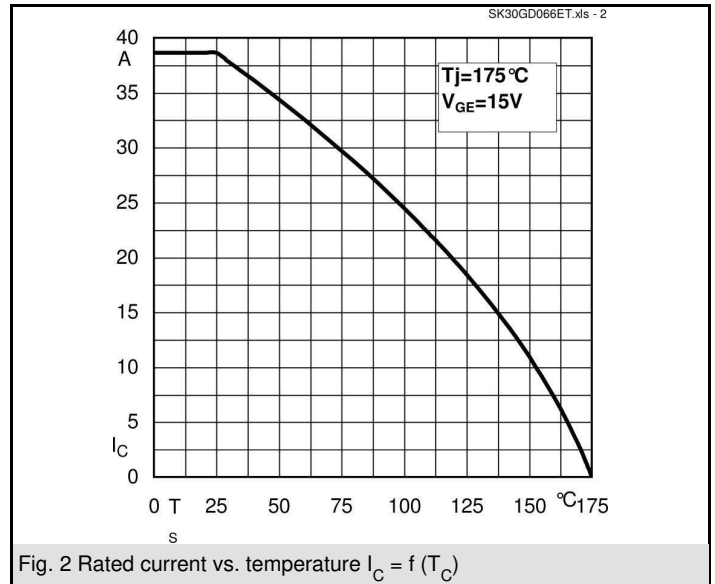
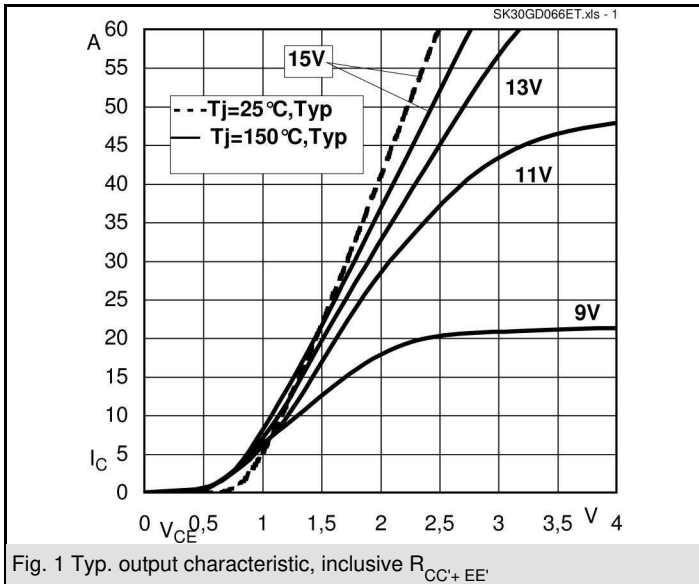

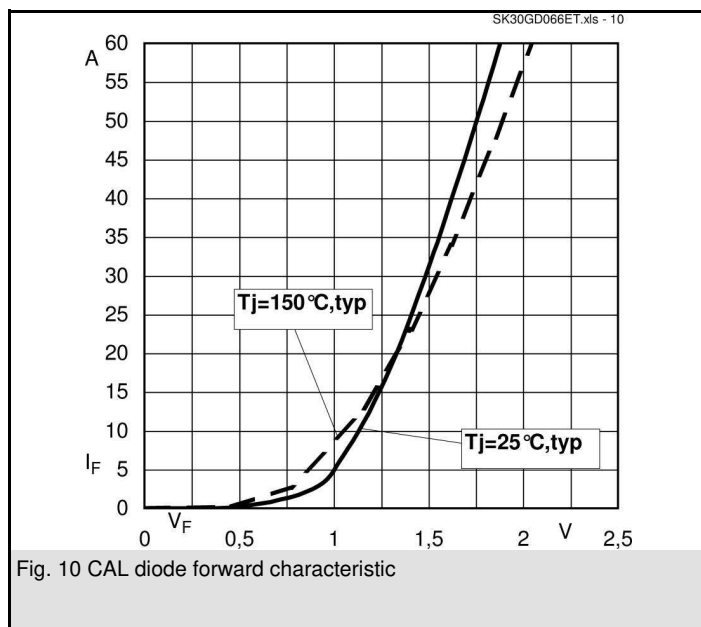
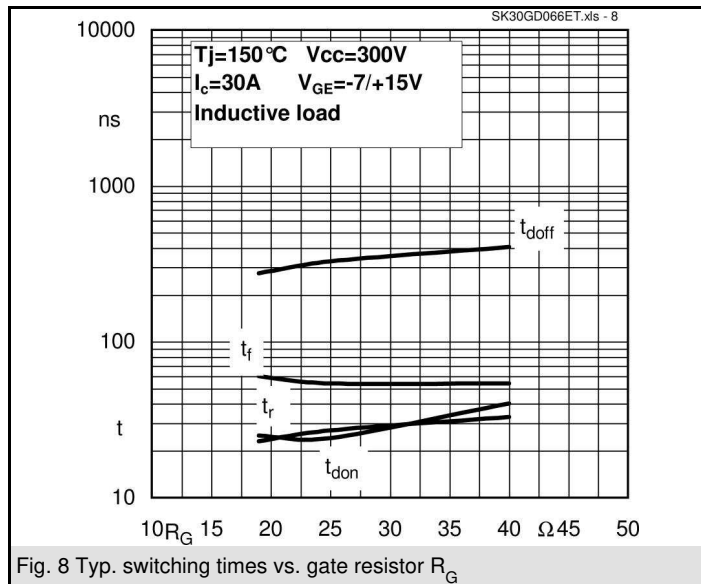
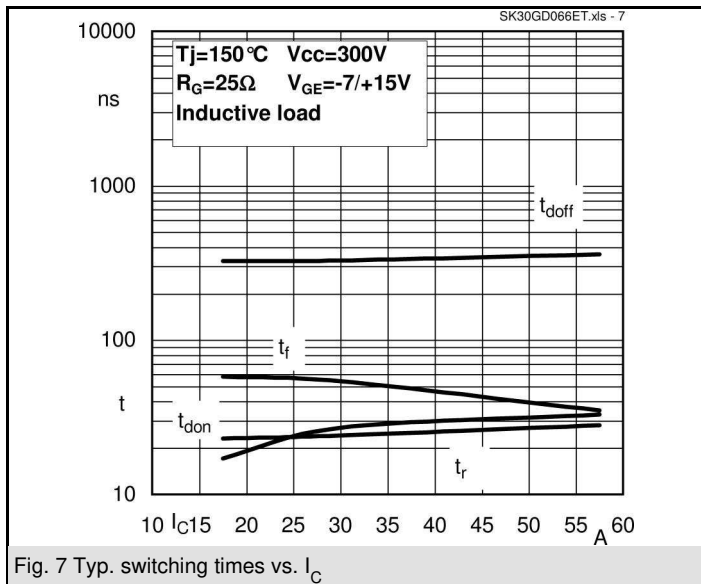

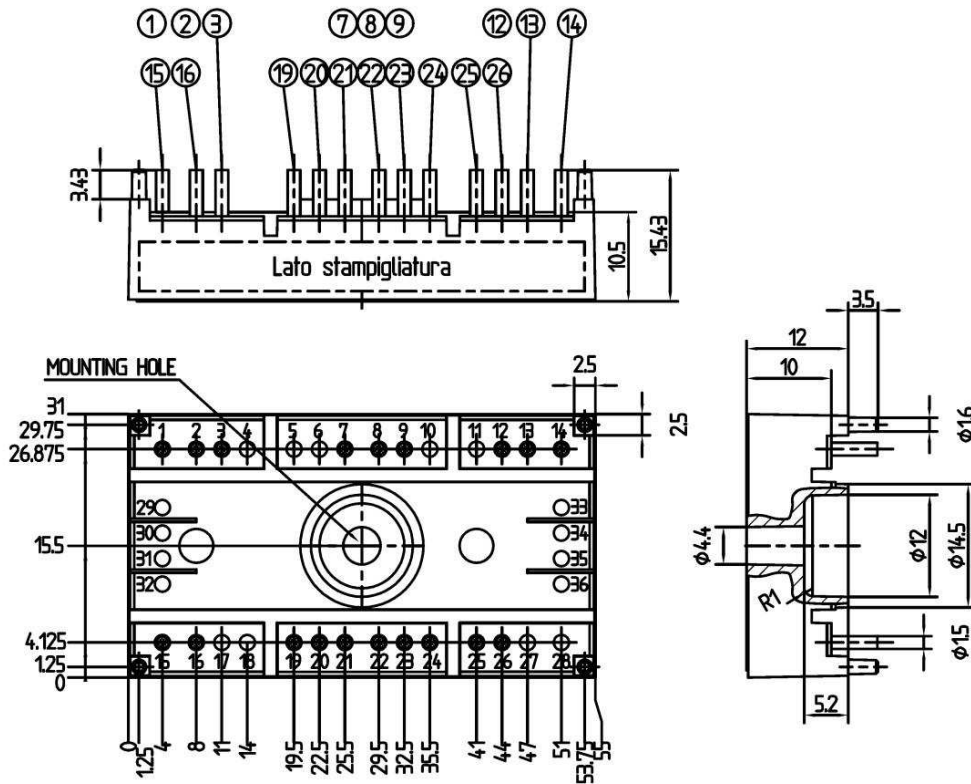

Case T52 (Suggested hole diameter, in the PCB, for solder pins and plastic mounting pins: 2mm)

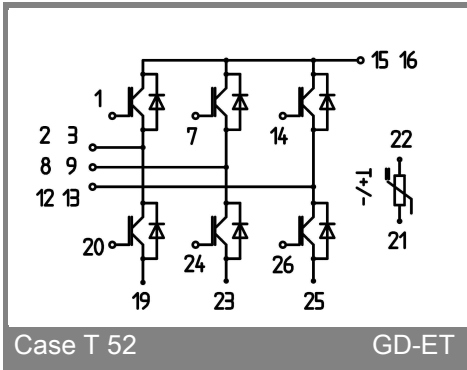

Case T 52

GD-ET