

SKM400GB126D



SEMITRANS® 3

Trench IGBT Modules

SKM400GB126D

Features

- Trench = Trenchgate technology
- $V_{CE(sat)}$ with positive temperature coefficient
- High short circuit capability, self limiting to $6 \times I_C$
- UL recognized, file no. E63532

Typical Applications*

- AC inverter drives
- UPS
- Electronic welders

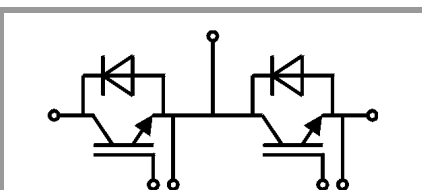

GB

Absolute Maximum Ratings				
Symbol	Conditions	Values	Unit	
IGBT				
V_{CES}	$T_j = 25\text{ °C}$	1200	V	
I_C	$T_j = 150\text{ °C}$	$T_c = 25\text{ °C}$	470	A
		$T_c = 80\text{ °C}$	327	A
I_{Cnom}		300	A	
I_{CRM}	$I_{CRM} = 2 \times I_{Cnom}$	600	A	
V_{GES}		-20 ... 20	V	
t_{psc}	$V_{CC} = 600\text{ V}$ $V_{GE} \leq 15\text{ V}$ $V_{CES} \leq 1200\text{ V}$	$T_j = 125\text{ °C}$	10	μs
T_j		-40 ... 150	$^{\circ}\text{C}$	
Inverse diode				
I_F	$T_j = 150\text{ °C}$	$T_c = 25\text{ °C}$	352	A
		$T_c = 80\text{ °C}$	240	A
I_{Fnom}		300	A	
I_{FRM}	$I_{FRM} = 2 \times I_{Fnom}$	600	A	
I_{FSM}	$t_p = 10\text{ ms, sin } 180^{\circ}, T_j = 25\text{ °C}$	2844	A	
T_j		-40 ... 150	$^{\circ}\text{C}$	
Module				
$I_{t(RMS)}$		500	A	
T_{stg}		-40 ... 125	$^{\circ}\text{C}$	
V_{isol}	AC sinus 50 Hz, $t = 1\text{ min}$	4000	V	

Characteristics					
Symbol	Conditions	min.	typ.	max.	Unit
IGBT					
$V_{CE(sat)}$	$I_C = 300\text{ A}$ $V_{GE} = 15\text{ V}$ chipelevel	$T_j = 25\text{ °C}$	1.69	2.10	V
		$T_j = 125\text{ °C}$	2.01	2.45	V
V_{CE0}	chipelevel	$T_j = 25\text{ °C}$	1	1.2	V
		$T_j = 125\text{ °C}$	0.9	1.1	V
r_{CE}	$V_{GE} = 15\text{ V}$ chipelevel	$T_j = 25\text{ °C}$	2.3	3	$\text{m}\Omega$
		$T_j = 125\text{ °C}$	3.7	4.5	$\text{m}\Omega$
$V_{GE(th)}$	$V_{GE} = V_{CE}, I_C = 12\text{ mA}$	5	5.8	6.5	V
I_{CES}	$V_{GE} = 0\text{ V}$ $V_{CE} = 1200\text{ V}$	$T_j = 25\text{ °C}$		4	mA
		$T_j = 125\text{ °C}$			mA
C_{ies}	$V_{CE} = 25\text{ V}$	$f = 1\text{ MHz}$	21.4		nF
C_{oes}	$V_{GE} = 0\text{ V}$	$f = 1\text{ MHz}$	1.12		nF
C_{res}		$f = 1\text{ MHz}$	0.97		nF
Q_G	$V_{GE} = -8\text{ V...} + 20\text{ V}$		2800		nC
R_{Gint}	$T_j = 25\text{ °C}$		2.5		Ω
$t_{d(on)}$	$V_{CC} = 600\text{ V}$ $I_C = 300\text{ A}$	$T_j = 125\text{ °C}$	330		ns
t_r	$V_{GE} = +15/-15\text{ V}$	$T_j = 125\text{ °C}$	50		ns
E_{on}	$R_{Gon} = 2\text{ }\Omega$	$T_j = 125\text{ °C}$	29		mJ
$t_{d(off)}$	$R_{Goff} = 2\text{ }\Omega$	$T_j = 125\text{ °C}$	650		ns
t_f		$T_j = 125\text{ °C}$	110		ns
E_{off}		$T_j = 125\text{ °C}$	48		mJ
$R_{th(j-c)}$	per IGBT			0.08	K/W

SKM400GB126D



SEMITRANS® 3

Trench IGBT Modules

SKM400GB126D

Features

- Trench = Trenchgate technology
- $V_{CE(sat)}$ with positive temperature coefficient
- High short circuit capability, self limiting to $6 \times I_C$
- UL recognized, file no. E63532

Typical Applications*

- AC inverter drives
- UPS
- Electronic welders

Characteristics						
Symbol	Conditions		min.	typ.	max.	Unit
Inverse diode						
$V_F = V_{EC}$	$I_F = 300 \text{ A}$ $V_{GE} = 0 \text{ V}$ chipllevel	$T_j = 25 \text{ °C}$		1.60	1.80	V
		$T_j = 125 \text{ °C}$		1.60	1.80	V
V_{F0}	chipllevel	$T_j = 25 \text{ °C}$		1	1.1	V
		$T_j = 125 \text{ °C}$		0.8	0.9	V
r_F	chipllevel	$T_j = 25 \text{ °C}$		2.00	2.3	mΩ
		$T_j = 125 \text{ °C}$		2.7	3	mΩ
I_{RRM}	$I_F = 300 \text{ A}$	$T_j = 125 \text{ °C}$		390		A
Q_{rr}	$di/dt_{off} = 6300 \text{ A/}\mu\text{s}$	$T_j = 125 \text{ °C}$		77		μC
E_{rr}	$V_{GE} = -15 \text{ V}$ $V_{CC} = 600 \text{ V}$	$T_j = 125 \text{ °C}$		27		mJ
$R_{th(j-c)}$	per diode				0.18	K/W
Module						
L_{CE}				15		nH
$R_{CC'+EE'}$	terminal-chip	$T_C = 25 \text{ °C}$		0.35		mΩ
		$T_C = 125 \text{ °C}$		0.5		mΩ
$R_{th(c-s)}$	per module			0.02	0.038	K/W
M_s	to heat sink M6			3	5	Nm
M_t		to terminals M6		2.5	5	Nm
						Nm
w					325	g

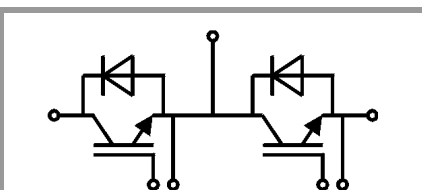

GB

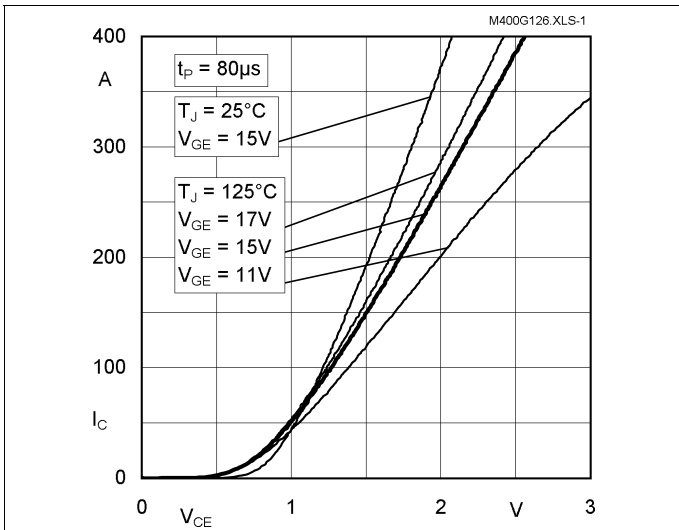

Fig. 1: Typ. output characteristic, inclusive $R_{CC'+EE'}$

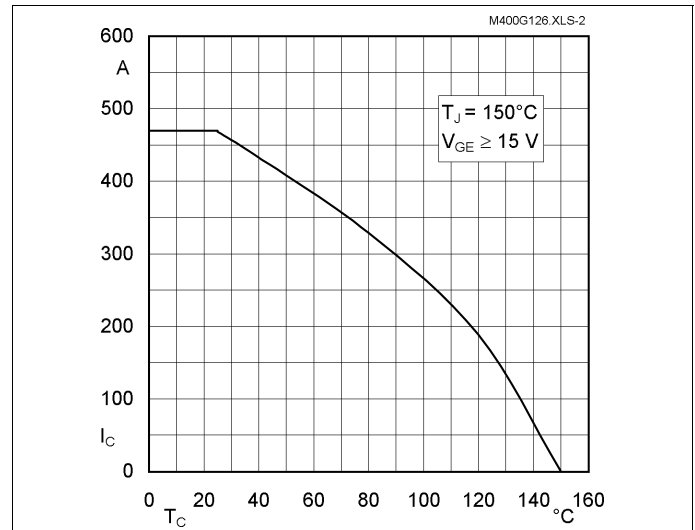

Fig. 2: Rated current vs. temperature $I_C = f(T_C)$

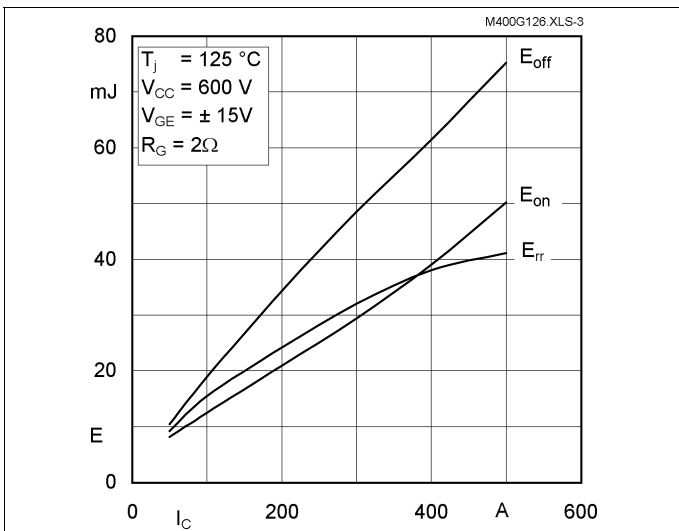

Fig. 3: Typ. turn-on /-off energy = $f(I_C)$

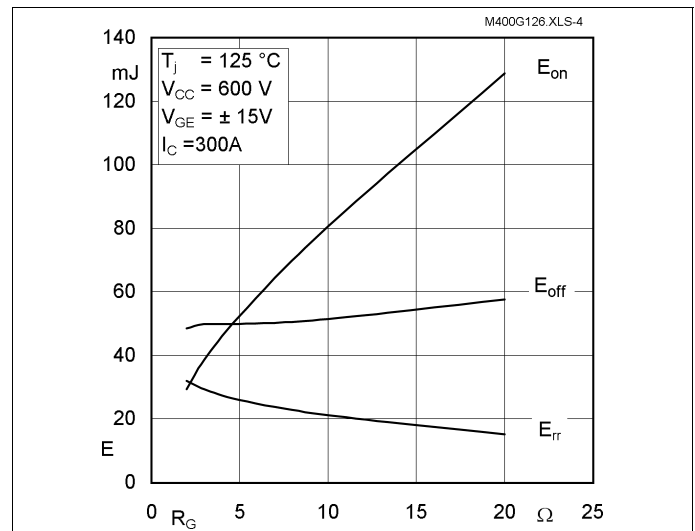

Fig. 4: Typ. turn-on /-off energy = $f(R_G)$

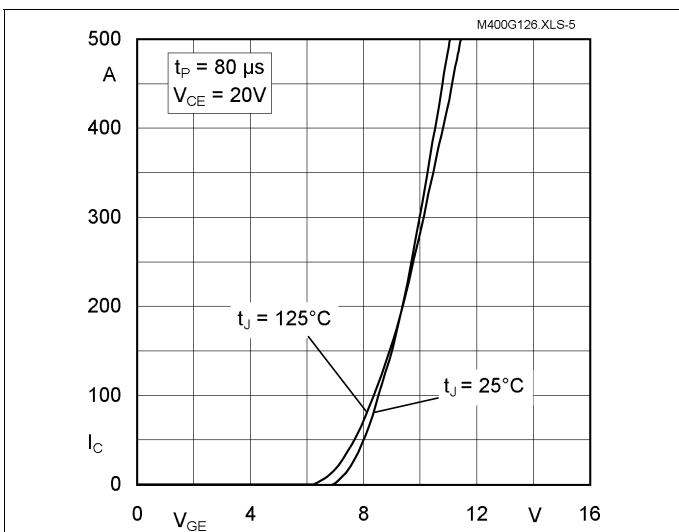

Fig. 5: Typ. transfer characteristic

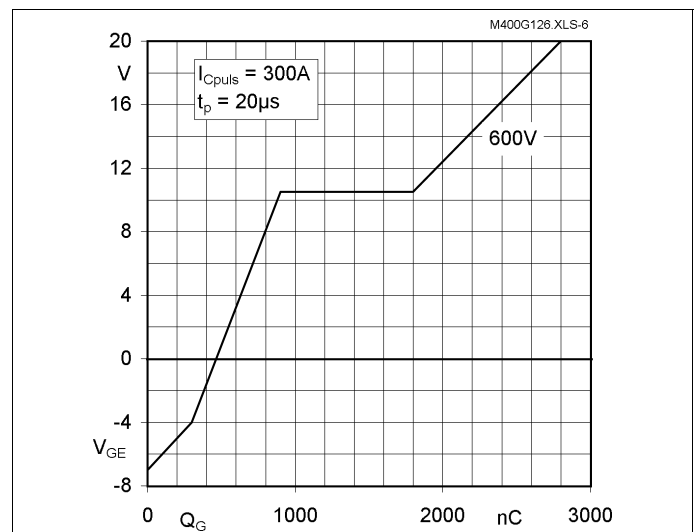

Fig. 6: Typ. gate charge characteristic

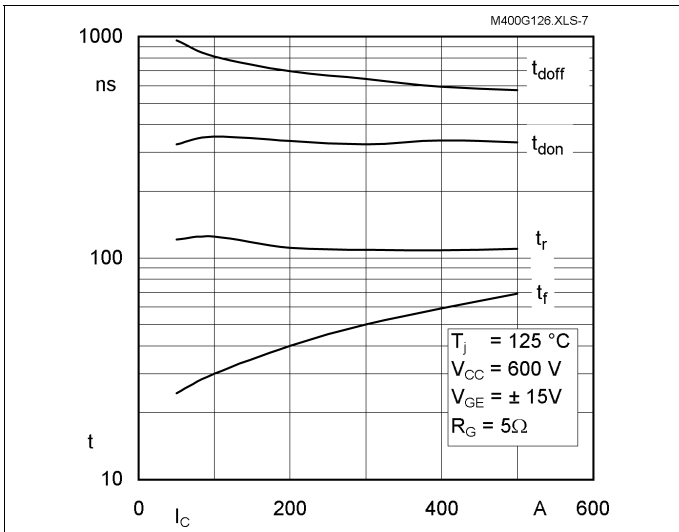

Fig. 7: Typ. switching times vs. I_C

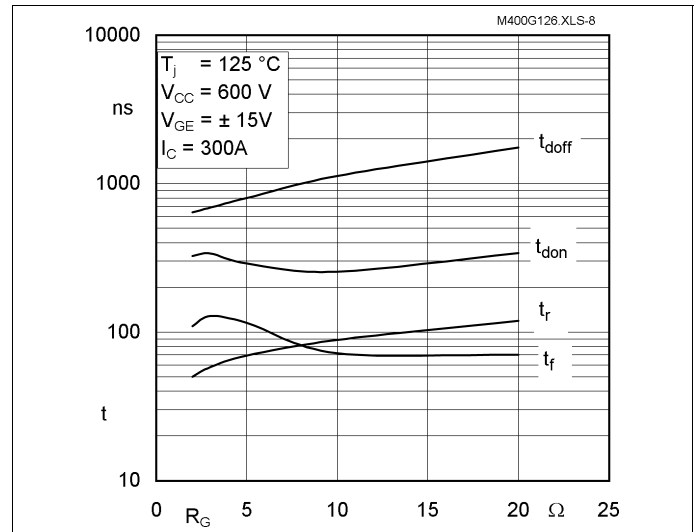

Fig. 8: Typ. switching times vs. gate resistor R_G

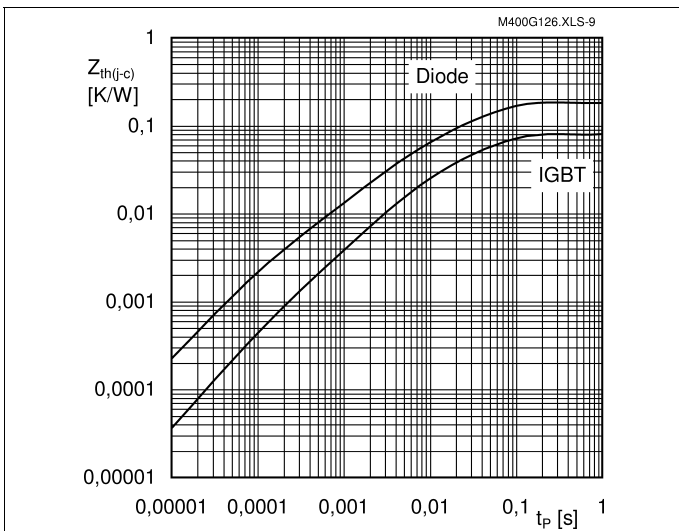

Fig. 9: Transient thermal impedance

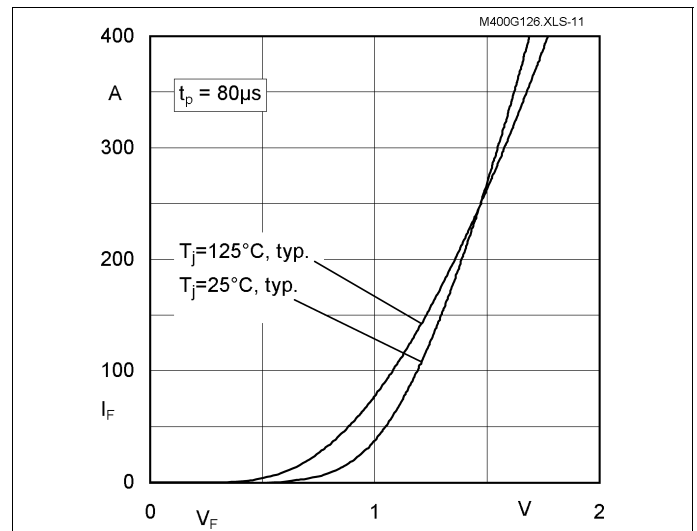

Fig. 10: Typ. CAL diode forward charact., incl. $R_{CC+EE'}$

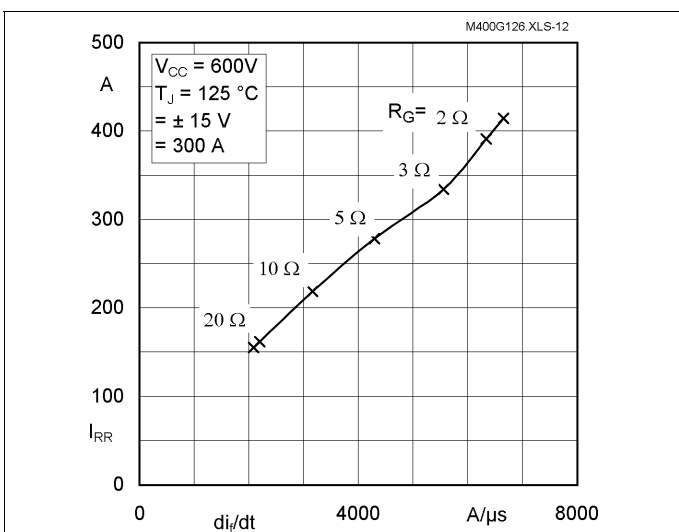

Fig. 11: Typ. CAL diode peak reverse recovery current

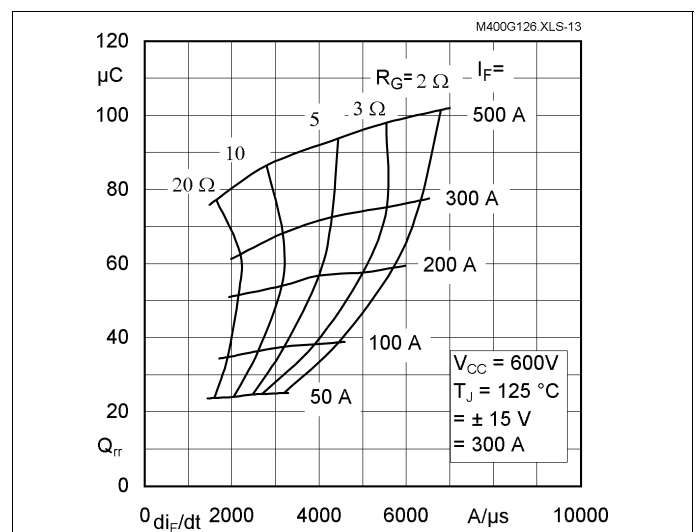
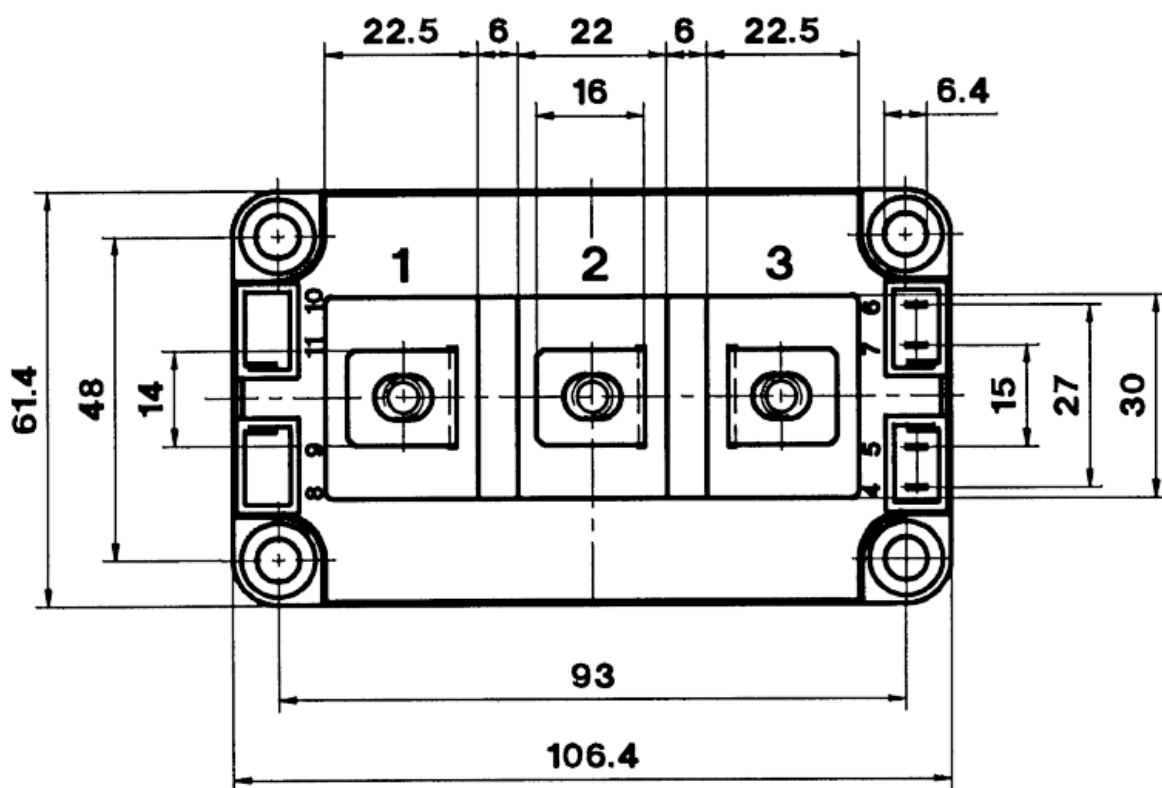
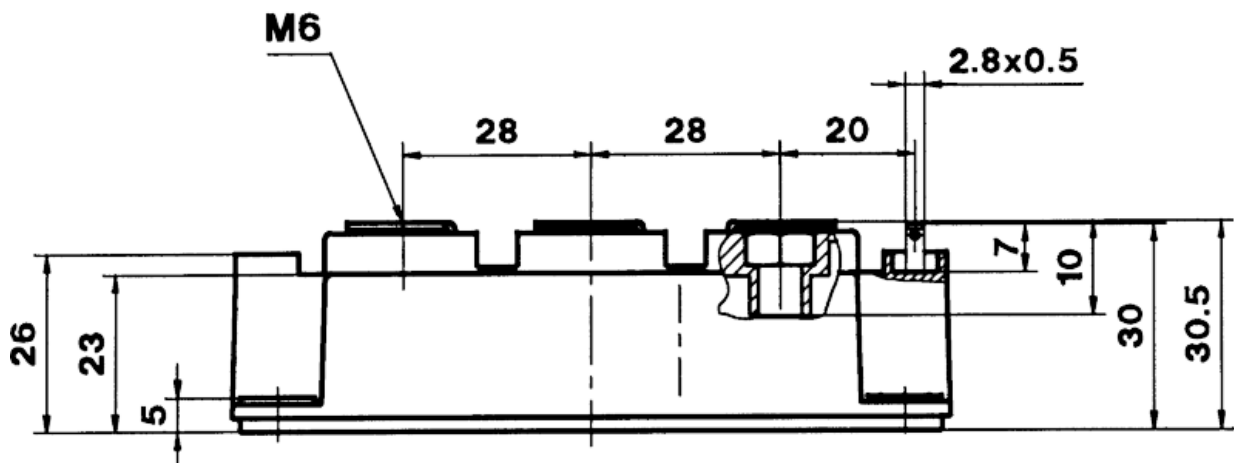
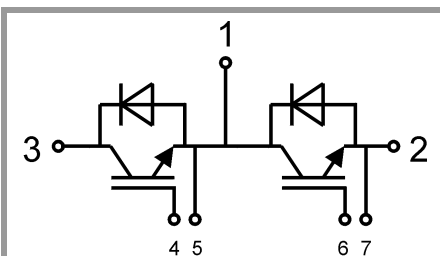

Fig. 12: Typ. CAL diode peak reverse recovery charge



SEMITRANS 3



GB

This is an electrostatic discharge sensitive device (ESDS), international standard IEC 60747-1, Chapter IX

* The specifications of our components may not be considered as an assurance of component characteristics. Components have to be tested for the respective application. Adjustments may be necessary. The use of SEMIKRON products in life support appliances and systems is subject to prior specification and written approval by SEMIKRON. We therefore strongly recommend prior consultation of our staff.