

V_{DRM}	=	4500 V
I_{TGQM}	=	3000 A
I_{TSM}	=	24×10^3 A
V_{T0}	=	2.2 V
r_{T}	=	0.6 m Ω
V_{Dclink}	=	2800 V

Asymmetric Gate turn-off Thyristor 5SGA 30J4502

Doc. No. 5SYA1202-03 Jan. 03

- Patented free-floating silicon technology
- Low on-state and switching losses
- Annular gate electrode
- Industry standard housing
- Cosmic radiation withstand rating

Blocking

Maximum rated values ¹⁾

Parameter	Symbol	Conditions	min	typ	max	Unit
Repetitive peak off-state voltage	V_{DRM}	$V_{\text{GR}} \geq 2$ V			4500	V
Repetitive peak reverse voltage	V_{RRM}				17	V
Permanent DC voltage for 100 FIT failure rate	V_{Dclink}	Ambient cosmic radiation at sea level in open air.			2800	V

Characteristic values

Parameter	Symbol	Conditions	min	typ	max	Unit
Repetitive peak off-state current	I_{DRM}	$V_{\text{D}} = V_{\text{DRM}}, V_{\text{GR}} \geq 2$ V			60	mA
Repetitive peak reverse current	I_{RRM}	$V_{\text{R}} = V_{\text{RRM}}, R_{\text{GK}} = \infty \Omega$			20	mA

Mechanical data

Maximum rated values ¹⁾

Parameter	Symbol	Conditions	min	typ	max	Unit
Mounting force	F_{m}		36	40	44	kN

Characteristic values

Parameter	Symbol	Conditions	min	typ	max	Unit
Pole-piece diameter	D_{p}	± 0.1 mm		75		mm
Housing thickness	H	± 0.5 mm		26		mm
Weight	m			1.3		kg
Surface creepage distance	D_{s}	Anode to Gate	33			mm
Air strike distance	D_{a}	Anode to Gate	15			mm

1) Maximum rated values indicate limits beyond which damage to the device may occur

ABB Switzerland Ltd, Semiconductors reserves the right to change specifications without notice.



GTO Data

On-state

Maximum rated values ¹⁾

Parameter	Symbol	Conditions	min	typ	max	Unit
Max. average on-state current	I_{TAVM}	Half sine wave, $T_C = 85^\circ\text{C}$			930	A
Max. RMS on-state current	I_{TRMS}				1460	A
Max. peak non-repetitive surge current	I_{TSM}	$t_p = 10\text{ ms}$, $T_{vj} = 125^\circ\text{C}$, sine wave After Surge: $V_D = V_R = 0\text{ V}$			24×10^3	A
Limiting load integral	I^2t				2.88×10^6	A^2s
Max. peak non-repetitive surge current	I_{TSM}	$t_p = 1\text{ ms}$, $T_{vj} = 125^\circ\text{C}$, sine wave After Surge: $V_D = V_R = 0\text{ V}$			40×10^3	A
Limiting load integral	I^2t				800×10^3	A^2s

Characteristic values

Parameter	Symbol	Conditions	min	typ	max	Unit
On-state voltage	V_T	$I_T = 3000\text{ A}$, $T_{vj} = 125^\circ\text{C}$			4	V
Threshold voltage	$V_{(T0)}$	$T_{vj} = 125^\circ\text{C}$			2.2	V
Slope resistance	r_T	$I_T = 300 \dots 4000\text{ A}$			0.6	$\text{m}\Omega$
Holding current	I_H	$T_{vj} = 25^\circ\text{C}$			50	A

Turn-on switching

Maximum rated values ¹⁾

Parameter	Symbol	Conditions	min	typ	max	Unit
Critical rate of rise of on-state current	di_T/dt_{cr}	$T_{vj} = 125^\circ\text{C}$, $f = 200\text{ Hz}$			400	$\text{A}/\mu\text{s}$
Critical rate of rise of on-state current	di_T/dt_{cr}	$I_T = 3000\text{ A}$, $I_{GM} = 30\text{ A}$, $di_G/dt = 20\text{ A}/\mu\text{s}$, $f = 1\text{ Hz}$			800	$\text{A}/\mu\text{s}$
Min. on-time	t_{on}		100			μs

Characteristic values

Parameter	Symbol	Conditions	min	typ	max	Unit
Turn-on delay time	t_d	$V_D = 0.5 V_{DRM}$, $T_{vj} = 125^\circ\text{C}$			3	μs
Rise time	t_r	$I_T = 3000\text{ A}$, $di/dt = 200\text{ A}/\mu\text{s}$, $I_{GM} = 30\text{ A}$, $di_G/dt = 20\text{ A}/\mu\text{s}$, $C_S = 6\text{ }\mu\text{F}$, $R_S = 5\text{ }\Omega$			6	μs
Turn-on energy per pulse	E_{on}				3.6	J

Turn-off switching

Maximum rated values ¹⁾

Parameter	Symbol	Conditions	min	typ	max	Unit
Max. controllable turn-off current	I_{TGQM}	$V_{DM} \leq V_{DRM}$, $di_{GQ}/dt = 40\text{ A}/\mu\text{s}$, $C_S = 6\text{ }\mu\text{F}$, $L_S \leq 0.3\text{ }\mu\text{H}$			3000	A
Min. off-time	t_{off}		80			μs

Characteristic values

Parameter	Symbol	Conditions	min	typ	max	Unit
Storage time	t_s	$V_D = 0.5 V_{DRM}$, $T_{vj} = 125^\circ\text{C}$			25	μs
Fall time	t_f	$V_{DM} \leq V_{DRM}$, $di_{GQ}/dt = 40\text{ A}/\mu\text{s}$, $I_{TGQ} = I_{TGQM}$			3	μs
Turn-on energy per pulse	E_{off}	$R_S = 5\text{ }\Omega$, $C_S = 6\text{ }\mu\text{F}$, $L_S = 0.3\text{ }\mu\text{H}$			13	J
Peak turn-off gate current	I_{GQM}				900	A

Gate

Maximum rated values ¹⁾

Parameter	Symbol	Conditions	min	typ	max	Unit
Repetitive peak reverse voltage	V _{GRM}				17	V
Repetitive peak reverse current	I _{GRM}	V _{GR} = V _{GRM}			20	mA

Characteristic values

Parameter	Symbol	Conditions	min	typ	max	Unit
Gate trigger voltage	V _{GT}	T _{vj} = 25°C,		1		V
Gate trigger current	I _{GT}	V _D = 24 V, R _A = 0.1 Ω		3		A

Thermal

Maximum rated values ¹⁾

Parameter	Symbol	Conditions	min	typ	max	Unit
Junction operating temperature	T _{vj}		-40		125	°C
Storage temperature range	T _{stg}		-40		125	°C

Characteristic values

Parameter	Symbol	Conditions	min	typ	max	Unit
Thermal resistance junction to case	R _{th(jc)}	Double side cooled			12	K/kW
	R _{th(jc)A}	Anode side cooled			22	K/kW
	R _{th(jc)C}	Cathode side cooled			27	K/kW
Thermal resistance case to heatsink (Double side cooled)	R _{th(ch)}	Single side cooled			6	K/kW
	R _{th(ch)}	Double side cooled			3	K/kW

Analytical function for transient thermal impedance:

$$Z_{thJC}(t) = \sum_{i=1}^n R_i(1 - e^{-t/\tau_i})$$

i	1	2	3	4
R _i (K/kW)	5.400	4.500	1.700	0.400
τ _i (s)	1.2000	0.1700	0.0100	0.0010

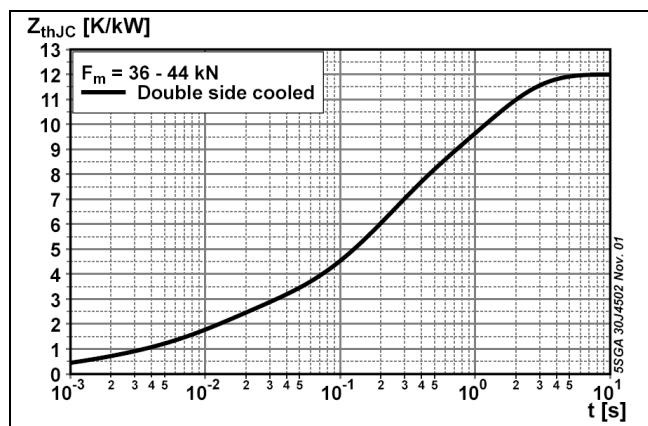

Fig. 1 Transient thermal impedance, junction to case.

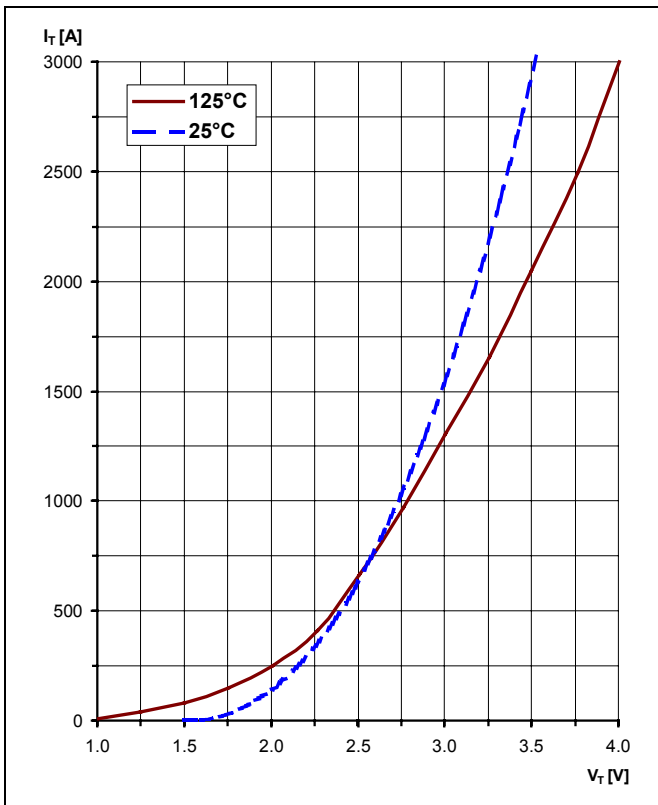

Fig. 2 On-state characteristics.

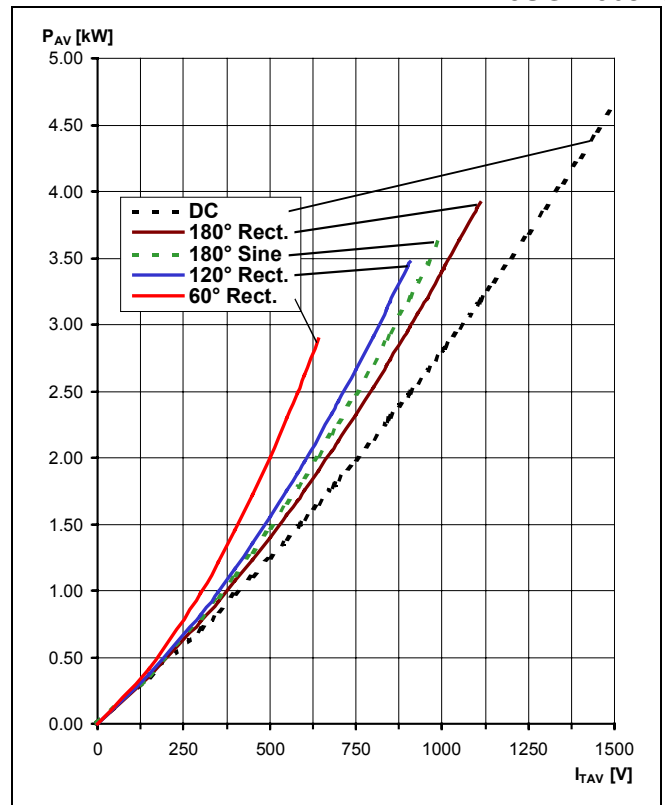

Fig. 3 Average on-state power dissipation vs. average on-state current..

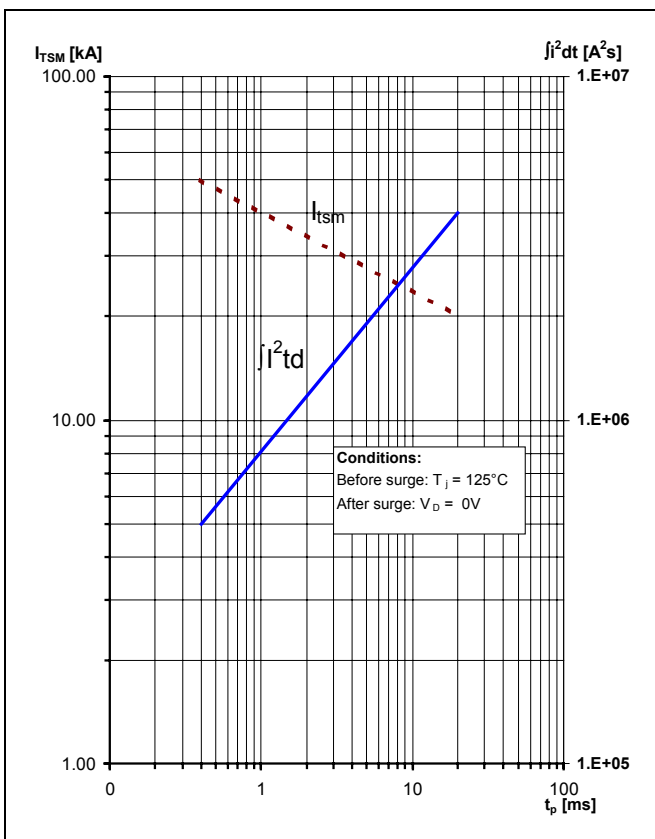

Fig. 4 Surge current and fusing integral vs. pulse width.

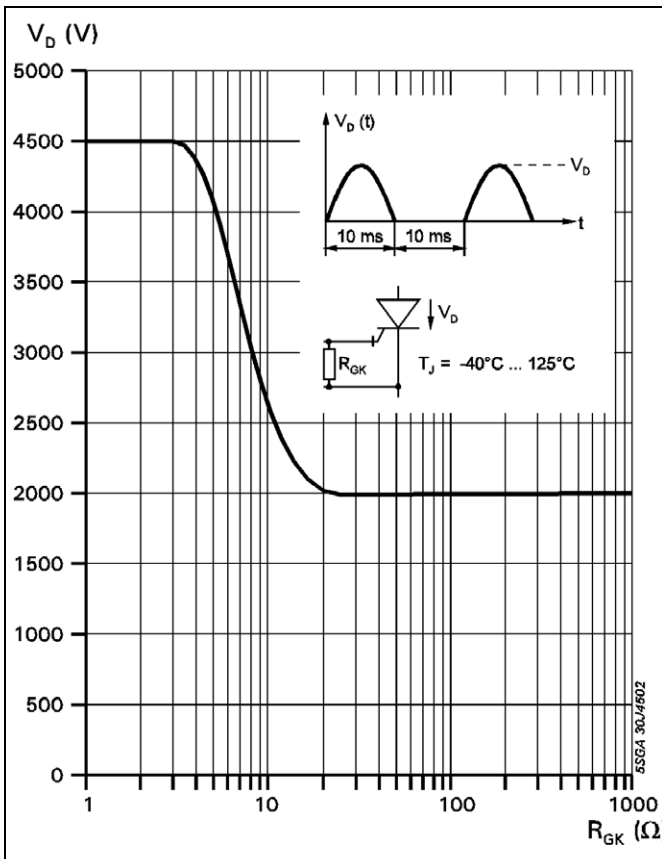

Fig. 5 Forward blocking voltage vs. gate-cathode resistance..

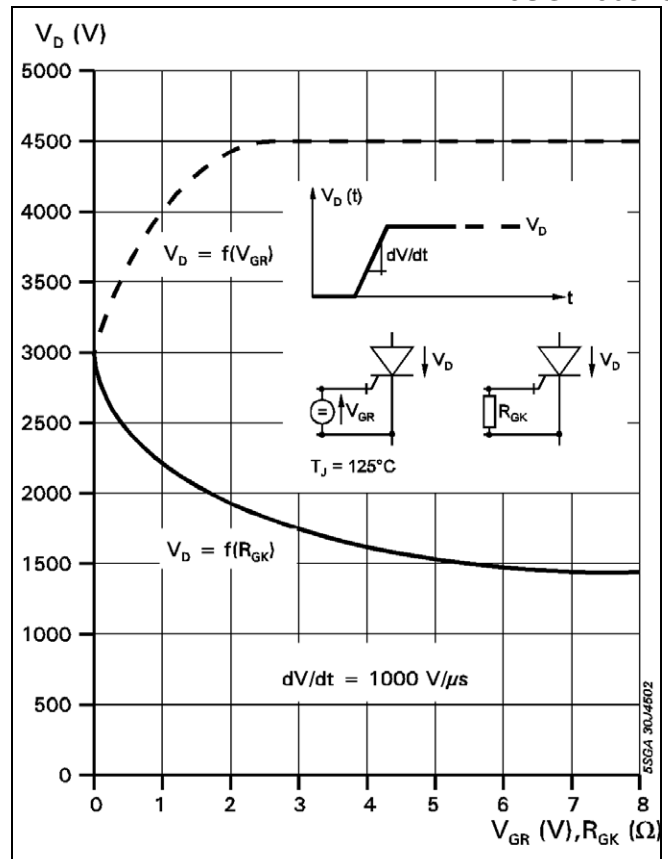

Fig. 6 Static dv/dt capability: Forward blocking voltage vs. neg. gate voltage or gate cathode resistance.

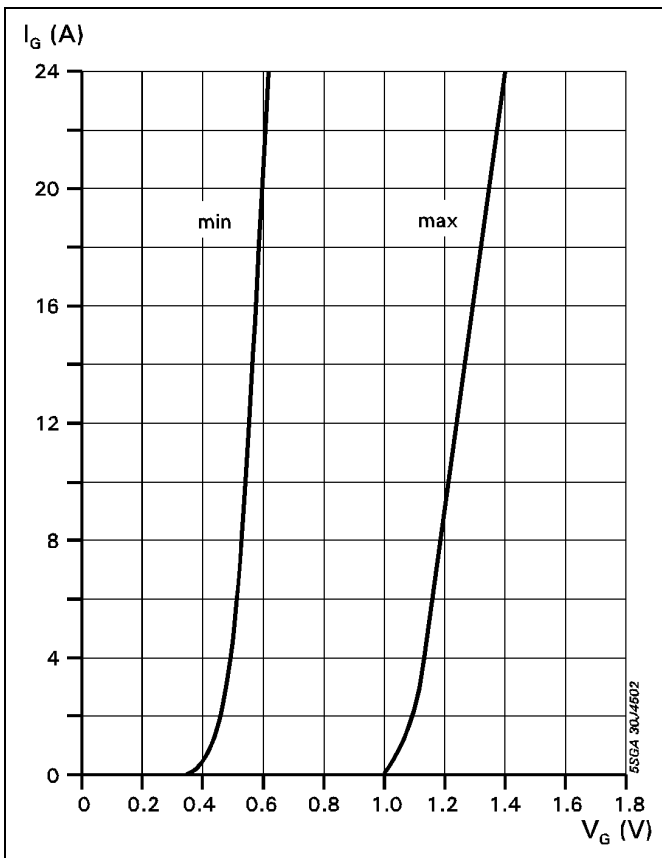

Fig. 7 Forward gate current vs. forward gate voltage.

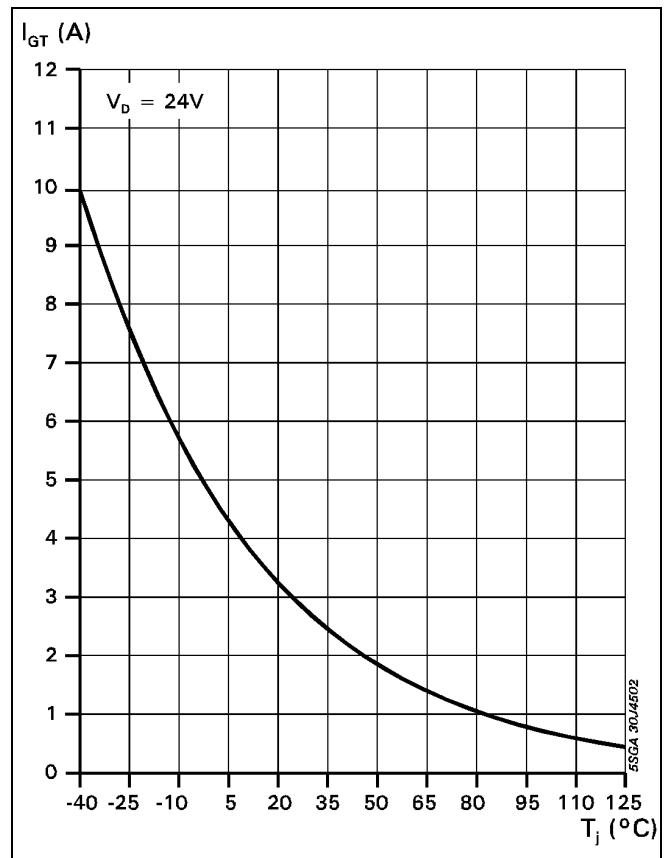

Fig. 8 Gate trigger current vs. junction temperature

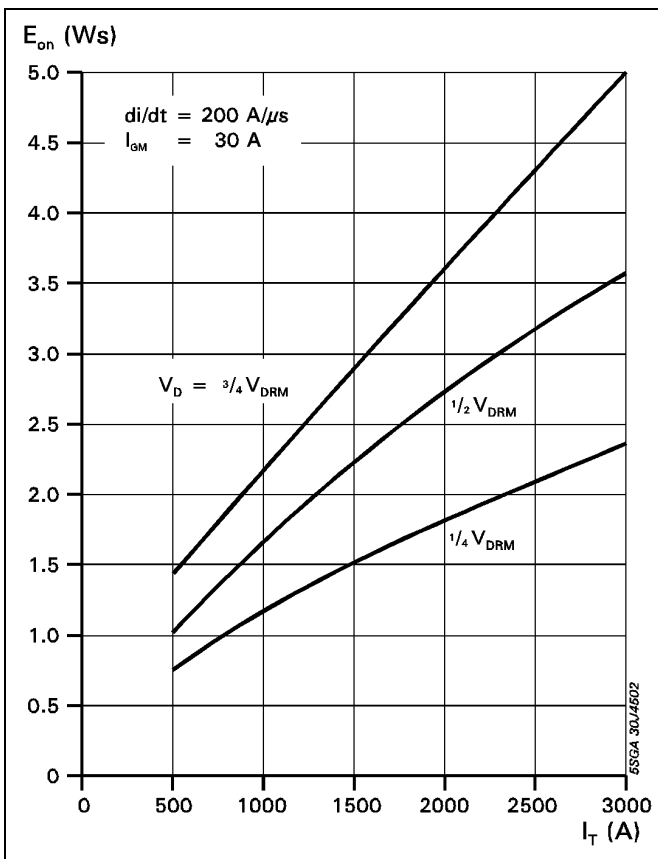

Fig. 9 Turn-on energy per pulse vs. on-state current and turn-on voltage.

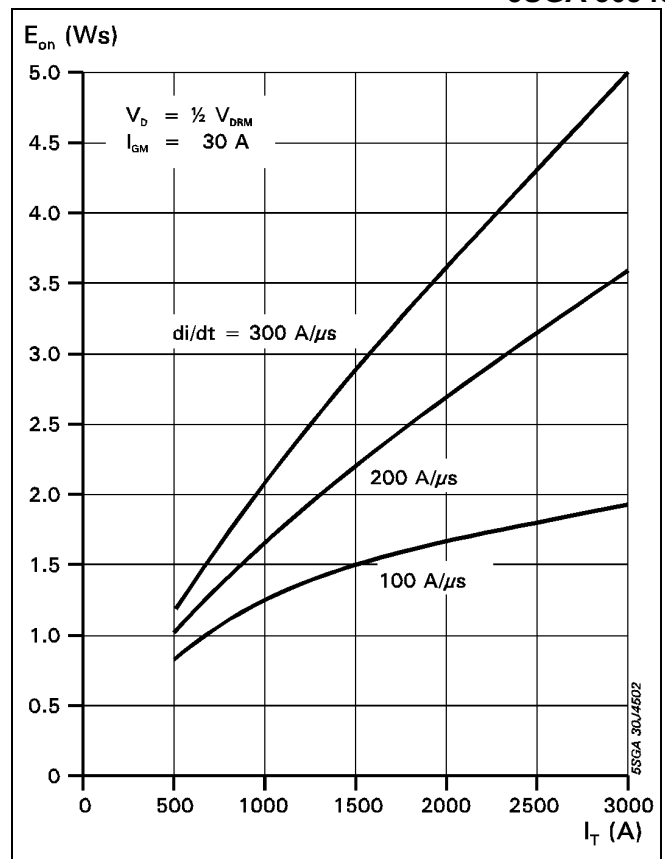

Fig. 10 Turn-on energy per pulse vs. on-state current and current rise rate

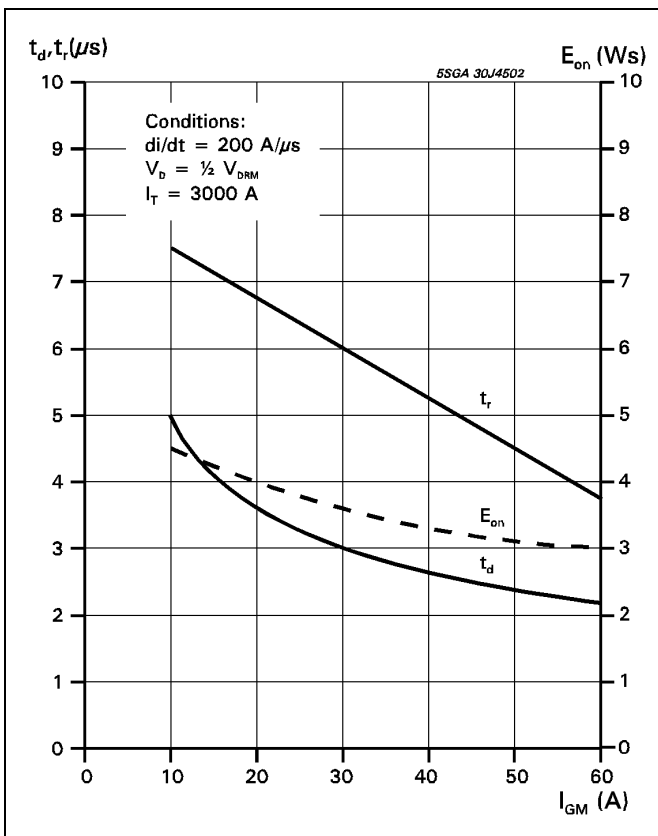

Fig. 11 Turn-on energy per pulse vs. on-state current and turn-on voltage.

Common Test conditions for figures 9, 10 and 11:

- $di_G/dt = 20 \text{ A}/\mu\text{s}$
- $C_S = 6 \mu\text{F}$
- $R_S = 5 \Omega$
- $T_j = 125 \text{ }^\circ\text{C}$

Definition of Turn-on energy:

$$E_{on} = \int_0^{20 \mu\text{s}} V_D \cdot I_T dt \quad (t = 0, I_G = 0.1 \cdot I_{GM})$$

Common Test conditions for figures 12, 13 and 15:

Definition of Turn-off energy:

$$E_{off} = \int_0^{40 \mu\text{s}} V_D \cdot I_T dt \quad (t = 0, I_T = 0.9 \cdot I_{TGO})$$

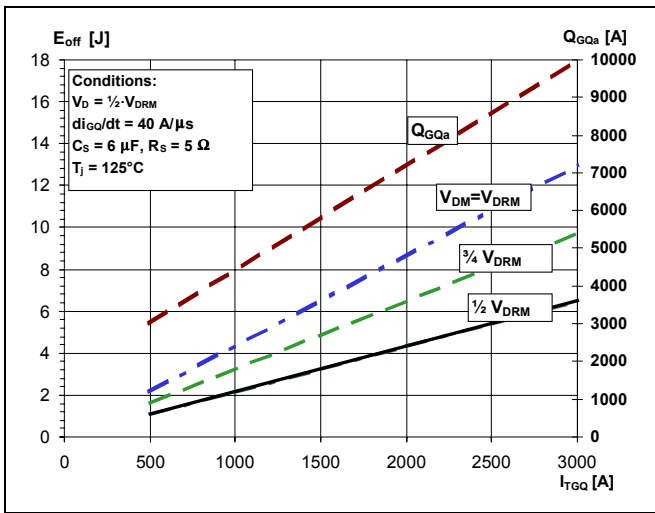

Fig. 12 Turn-off energy per pulse vs. turn-off current and peak turn-off voltage. Extracted gate charge vs. turn-off current.

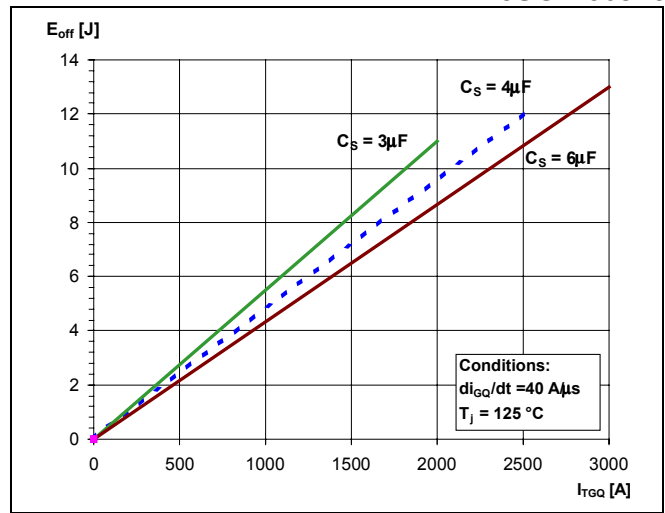

Fig. 13 Turn-off energy per pulse vs. turn-off current and snubber capacitance.

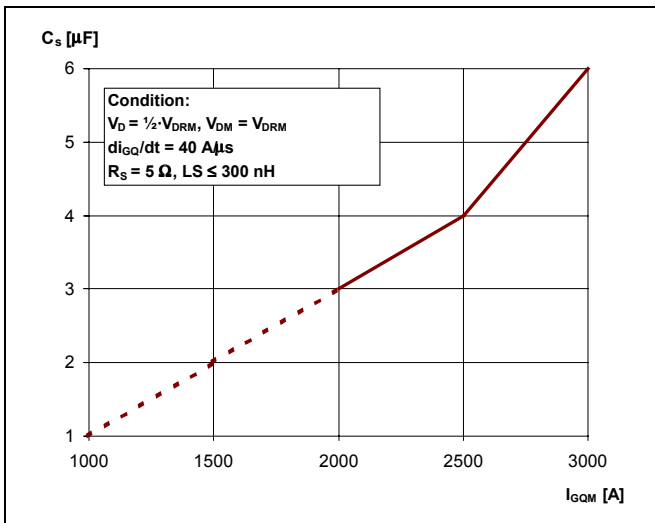

Fig. 14 Required snubber capacitor vs. max allowable turn-off current.

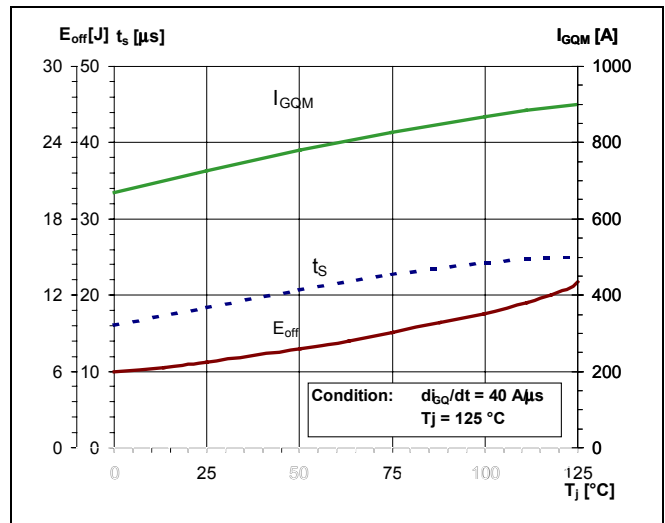

Fig. 15 Turn-off energy per pulse, storage time and peak turn-off gate current vs. junction temperature.

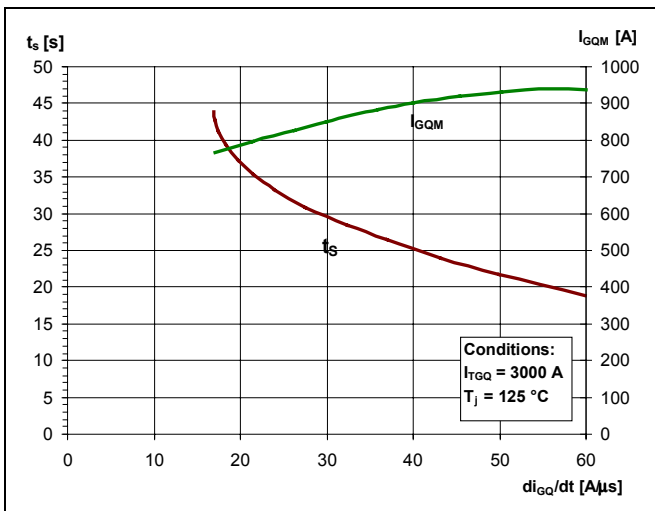

Fig. 16 Storage time and peak turn-off gate current vs. neg. gate current rise rate.

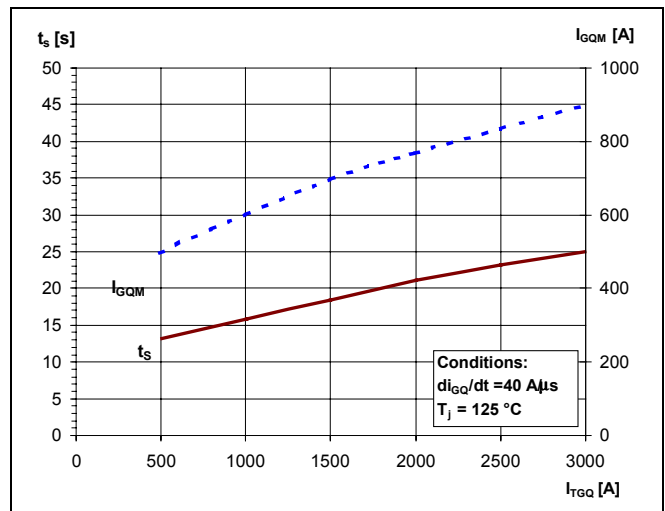

Fig. 17 Storage time and peak turn-off gate current vs. turn-off current.

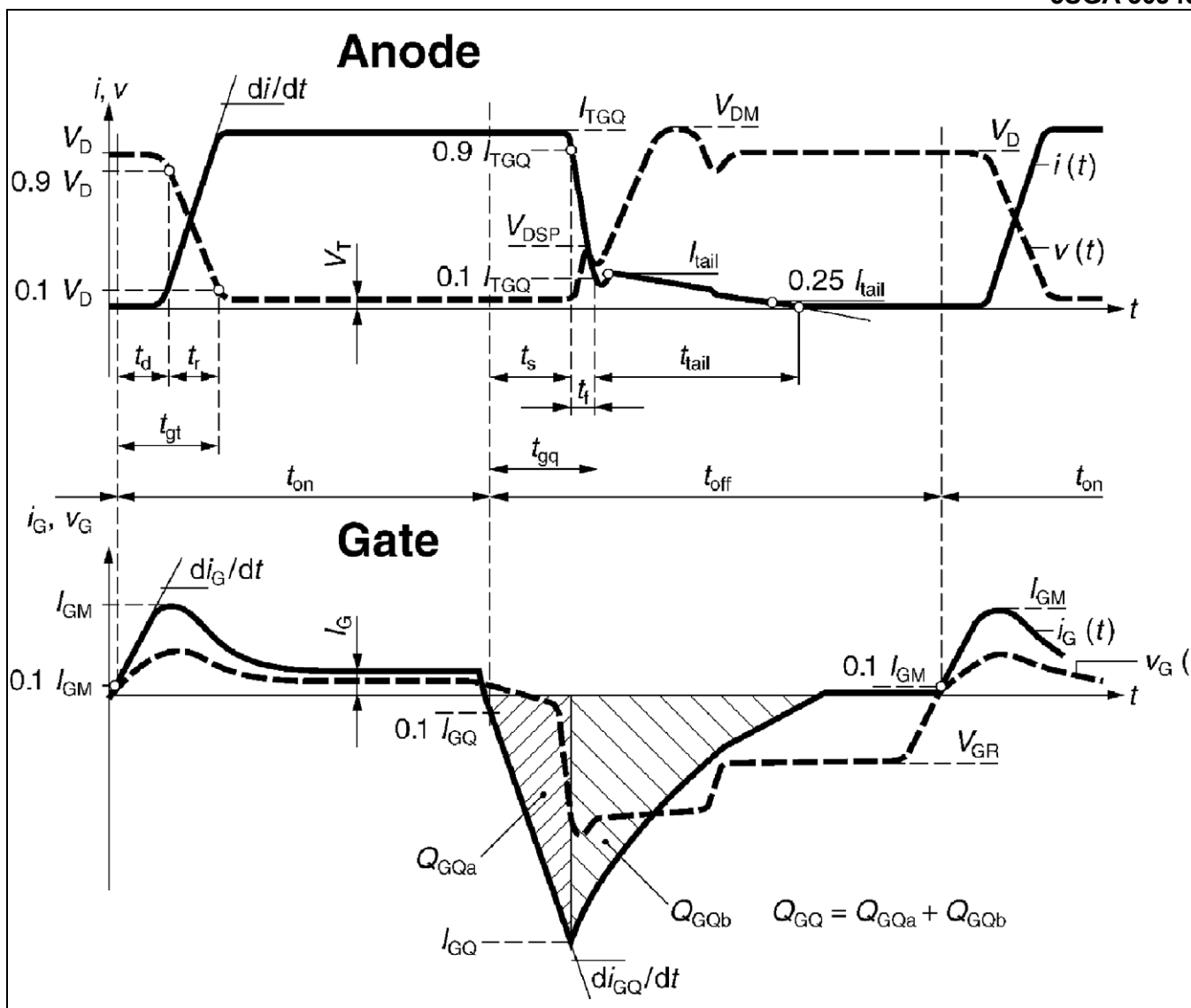

Fig. 18 General current and voltage waveforms with GTO-specific symbols.

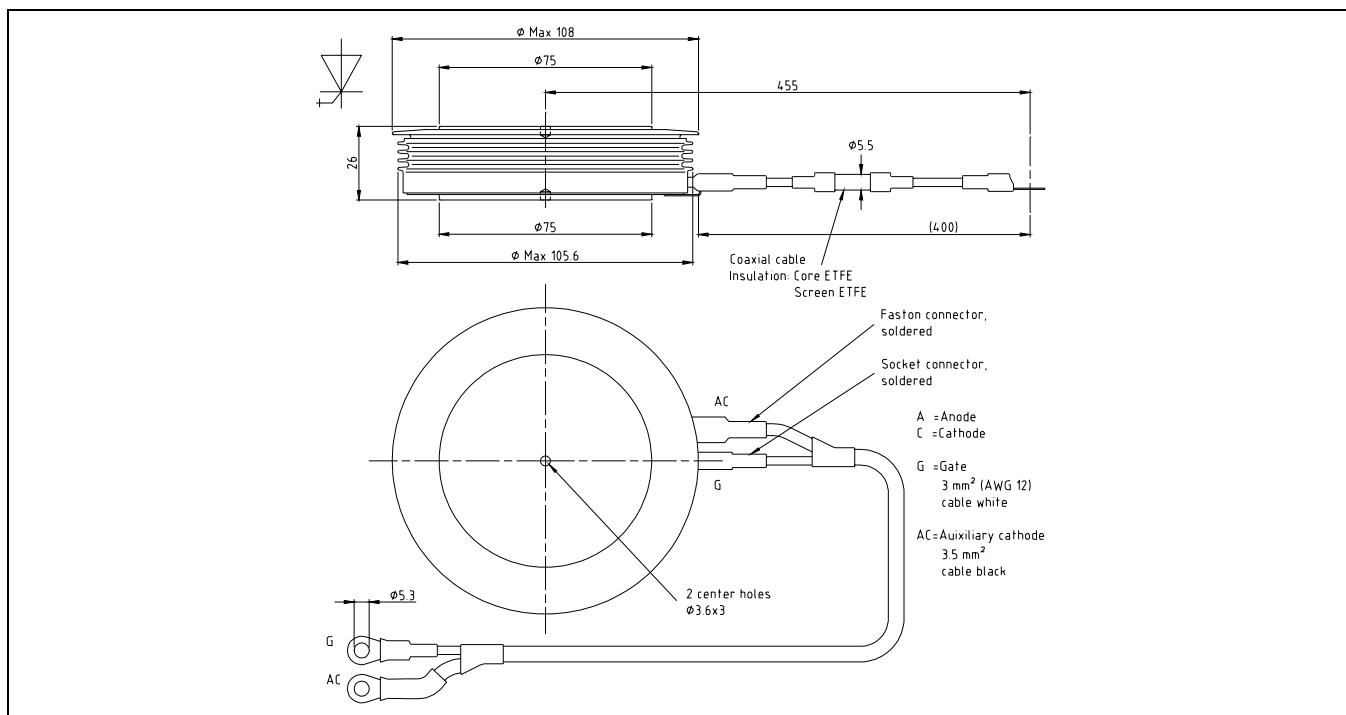

Fig. 19 Outline drawing. All dimensions are in millimeters and represent nominal values unless stated otherwise.

Reverse avalanche capability

In operation with an antiparallel freewheeling diode, the GTO reverse voltage V_R may exceed the rate value V_{RRM} due to stray inductance and diode turn-on voltage spike at high di/dt . The GTO is then driven into reverse avalanche. This condition is not dangerous for the GTO provided avalanche time and current are below 10 μ s and 1000 A respectively. However, gate voltage must remain negative during this time. Recommendation : $V_{GR} = 10... 15$ V.

ABB Switzerland Ltd, Semiconductors reserves the right to change specifications without notice.



ABB Switzerland Ltd
Semiconductors
Fabrikstrasse 3
CH-5600 Lenzburg, Switzerland

Doc. No. 5SYA1202-03 Jan. 03

Telephone +41 (0)58 586 1419
Fax +41 (0)58 586 1306
Email abbsem@ch.abb.com
Internet www.abb.com/semiconductors