

Rectifier Diode

Types W1032LC500 to W1032LC600

(Old Part Number: SW50-60CXC350)

Absolute Maximum Ratings

	VOLTAGE RATINGS	MAXIMUM LIMITS	UNITS
V _{RRM}	Repetitive peak reverse voltage, (note 1)	5000-6000	V
V _{RSM}	Non-repetitive peak reverse voltage, (note 1)	5100-6100	V

	OTHER RATINGS	MAXIMUM LIMITS	UNITS
I _{F(AV)M}	Maximum average forward current, T _{sink} =55°C, (note 2)	1032	A
I _{F(AV)M}	Maximum average forward current. T _{sink} =100°C, (note 2)	689	A
I _{F(AV)M}	Nominal RMS forward current, T _{sink} =100°C, (note 3)	432	A
I _{F(RMS)M}	Nominal RMS forward current, T _{sink} =25°C, (note 2)	1912	A
I _{F(d.c.)}	D.C. forward current, T _{sink} =25°C, (note 4)	1717	A
I _{FSM}	Peak non-repetitive surge t _p =10ms, V _{rm} =0.6V _{RRM} , (note 5)	7200	A
I _{FSM2}	Peak non-repetitive surge t _p =10ms, V _{rm} ≤10V, (note 5)	8000	A
I ² t	I ² t capacity for fusing t _p =10ms, V _{rm} =0.6V _{RRM} , (note 5)	259×10 ³	A ² s
I ² t	I ² t capacity for fusing t _p =10ms, V _{rm} ≤10V, (note 5)	320×10 ³	A ² s
T _{j op}	Operating temperature range	-40 to +150	°C
T _{stg}	Storage temperature range	-55 to +150	°C

Notes:-

- 1) De-rating factor of 0.13% per °C is applicable for T_j below 25°C.
- 2) Double side cooled, single phase; 50Hz, 180° half-sinewave.
- 3) Single side cooled, single phase; 50Hz, 180° half-sinewave.
- 4) Double side cooled.
- 5) Half-sinewave, 150°C T_j initial.

Characteristics

	PARAMETER	MIN.	TYP.	MAX.	TEST CONDITIONS (Note 1)	UNITS
V _{FM}	Maximum peak forward voltage	-	-	2.7	I _{TM} =2420A	V
V _{T0}	Threshold voltage	-	-	1.0		V
r _T	Slope resistance	-	-	0.702		mΩ
I _{RRM}	Peak reverse current	-	-	30	Rated V _{RRM}	mA
I _{RRM}	Peak reverse current	-	-	30	Rated V _{RRM} , T _j =25°C	mA
Q _{rr}	Total recovered charge	-	4400	-	I _{FM} =1000A, t _p =1ms, di/dt=10A/μs, V _r =50V	μC
Q _{ra}	Reverse recovery charge (50% chord)	-	1900	2050		μC
I _{rm}	Reverse recovery current	-	125	-		A
t _{rr}	Reverse recovery time (50% chord)	-	30	-		μs
R _{thJK}	Thermal resistance, junction to heatsink	-	-	0.033	Double side cooled	K/W
		-	-	0.066	Single side cooled	K/W
F	Mounting force	10	-	20		kN
W _t	Weight	-	340	-		g

Notes:-

 1) Unless otherwise indicated T_j=150°C.

Notes on Ratings and Characteristics

1.0 Voltage Grade Table

Voltage Grade	V _{RRM} V	V _{RSM} V	V _R DC V
50	5000	5100	2200
52	5200	5300	2240
54	5400	5500	2280
56	5600	5700	2320
58	5800	5900	2360
60	6000	6100	2400

2.0 De-rating Factor

A blocking voltage de-rating factor of 0.13%/°C is applicable to this device for T_j below 25°C.

3.0 Snubber Components

When selecting snubber components, care must be taken not to use excessively large values of snubber capacitor or excessively small values of snubber resistor. Such excessive component values may lead to device damage due to the large resultant values of snubber discharge current. If required, please consult the factory for assistance.

4.0 Computer Modelling Parameters

4.1 Device Dissipation Calculations

$$I_{AV} = \frac{-V_0 + \sqrt{V_0^2 + 4 \cdot ff^2 \cdot r_s \cdot W_{AV}}}{2 \cdot ff^2 \cdot r_s} \quad \text{and:} \quad W_{AV} = \frac{\Delta T}{R_{th}}$$

$$\Delta T = T_{j \max} - T_{Hs}$$

Where V₀=1.0V, r_s=0.702mΩ,

R_{th} = Supplementary thermal impedance, see table below.

ff = Form factor, see table below.

Supplementary Thermal Impedance (at 50Hz operating frequency)				
Conduction Angle	6 phase (60°)	3 phase (120°)	Half wave (180°)	d.c.
Square wave Double Side Cooled	0.045	0.040	0.036	0.033
Square wave Single Side Cooled	0.081	0.075	0.070	0.066
Sine wave Double Side Cooled	0.042	0.038	0.034	
Sine wave Single Side Cooled	0.079	0.072	0.067	

Conduction Angle	6 phase (60°)	3 phase (120°)	Half wave (180°)	d.c.
Square wave	2.45	1.73	1.41	1
Sine wave	2.78	1.88	1.57	

4.2 Calculating V_F using ABCD Coefficients

The forward characteristic I_F vs. V_F , on page 5 is represented in two ways;

- (i) the well established V_{T0} and r_T tangent used for rating purposes and
- (ii) a set of constants A, B, C, D, forming the coefficients of the representative equation for V_F in terms of I_F given below:

$$V_F = A + B \cdot \ln(I_F) + C \cdot I_F + D \cdot \sqrt{I_F}$$

The constants, derived by curve fitting software, are given below for both hot and cold characteristics. The resulting values for V_F agree with the true device characteristic over a current range, which is limited to that plotted.

25°C Coefficients		150°C Coefficients	
A	0.786727	A	0.5103767
B	0.06700378	B	0.1000737
C	5.405371×10^{-4}	C	7.364539×10^{-4}
D	-5.209484×10^{-3}	D	-7.568512×10^{-3}

4.3 D.C. Thermal Impedance Calculation

$$r_t = \sum_{p=1}^{p=n} r_p \cdot \left(1 - e^{-\frac{t}{\tau_p}} \right)$$

Where $p = 1$ to n , n is the number of terms in the series and:

- t = Duration of heating pulse in seconds.
- r_t = Thermal resistance at time t .
- r_p = Amplitude of p_{th} term.
- τ_p = Time Constant of r_{th} term.

D.C. Double Side Cooled				
Term	1	2	3	4
r_p	0.01771901	4.240625×10^{-3}	6.963806×10^{-3}	3.043661×10^{-3}
τ_p	0.7085781	0.1435833	0.03615196	2.130842×10^{-3}

D.C. Single Side Cooled					
Term	1	2	3	4	5
r_p	0.04013371	8.832199×10^{-3}	9.210899×10^{-3}	3.73647×10^{-3}	2.594797×10^{-3}
τ_p	4.073105	1.196877	0.09882439	0.01585017	2.077263×10^{-3}

Curves

Figure 1 – Forward characteristics of Limit device

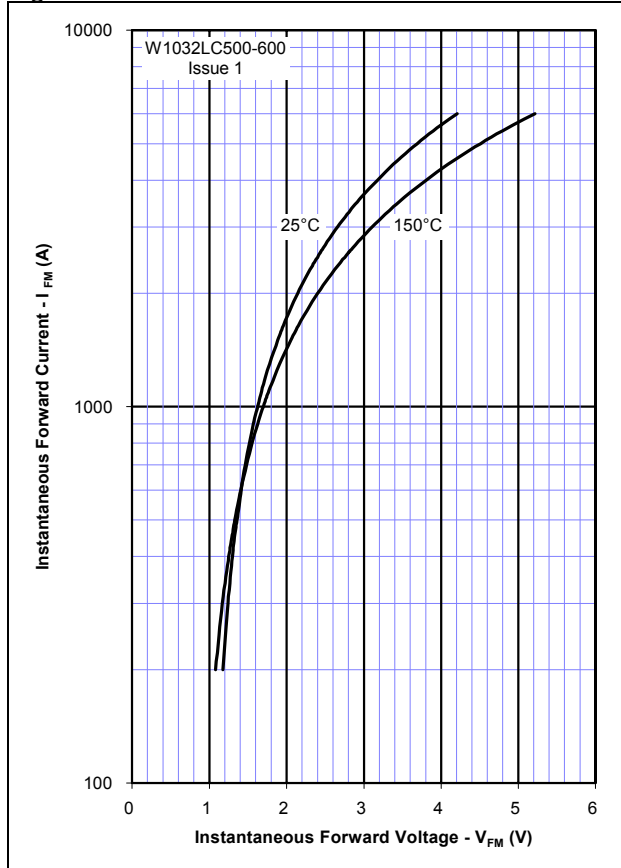

Figure 2 – Transient Thermal Impedance

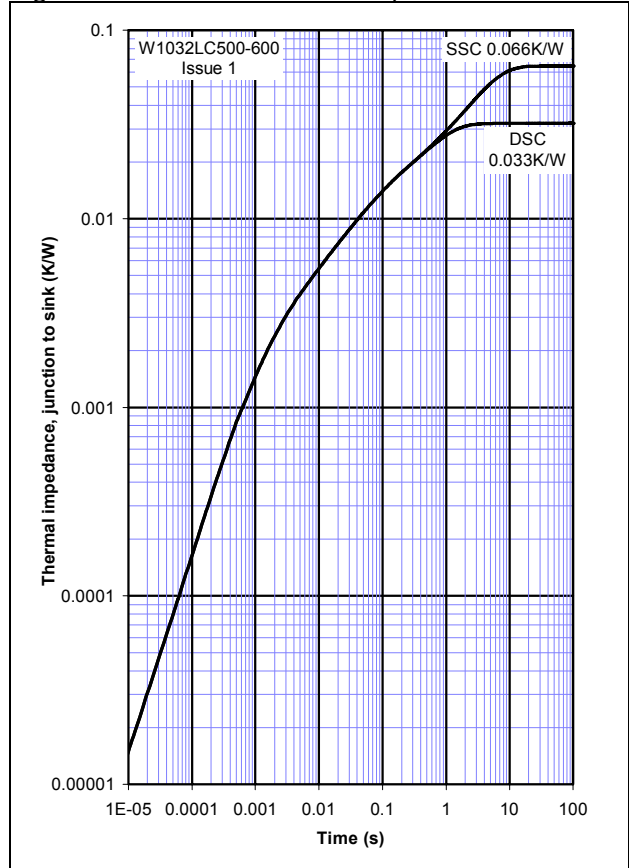

Figure 3 – Maximum surge and I^2t Ratings

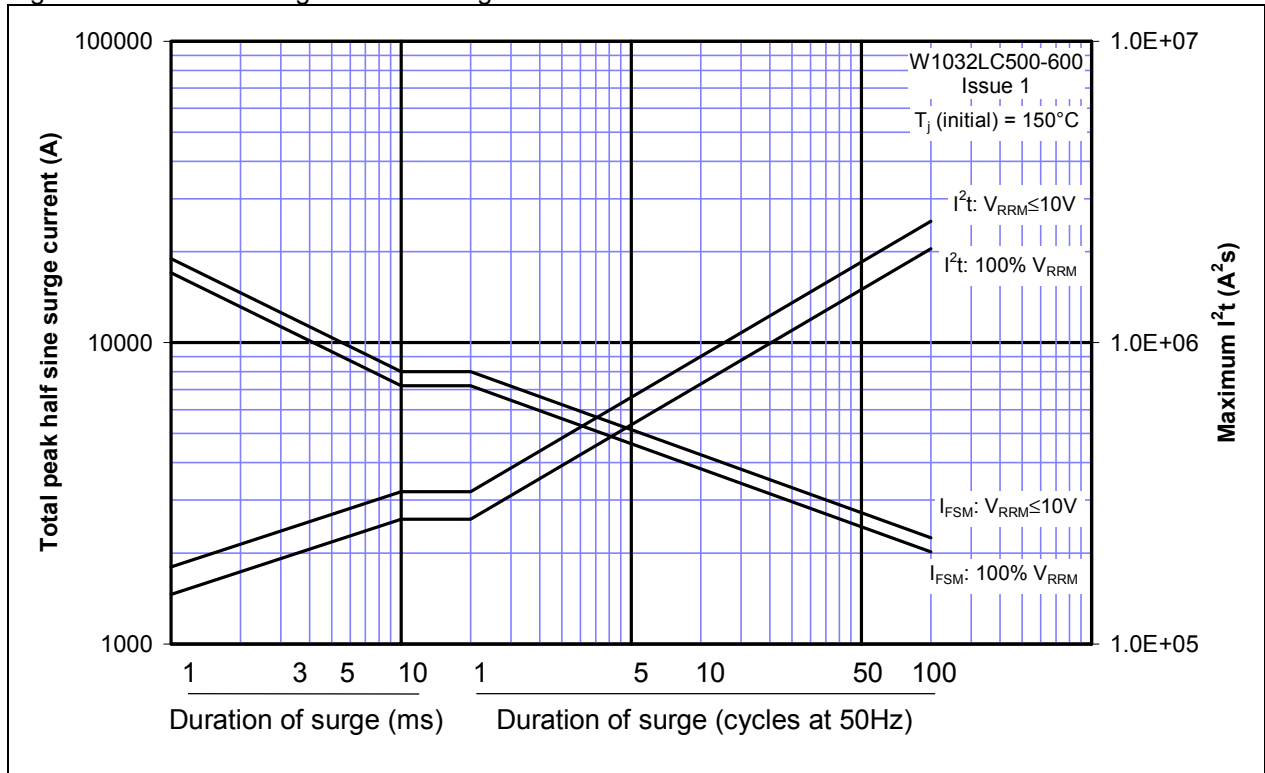

Figure 4 – Total recovered charge, Q_{rr}

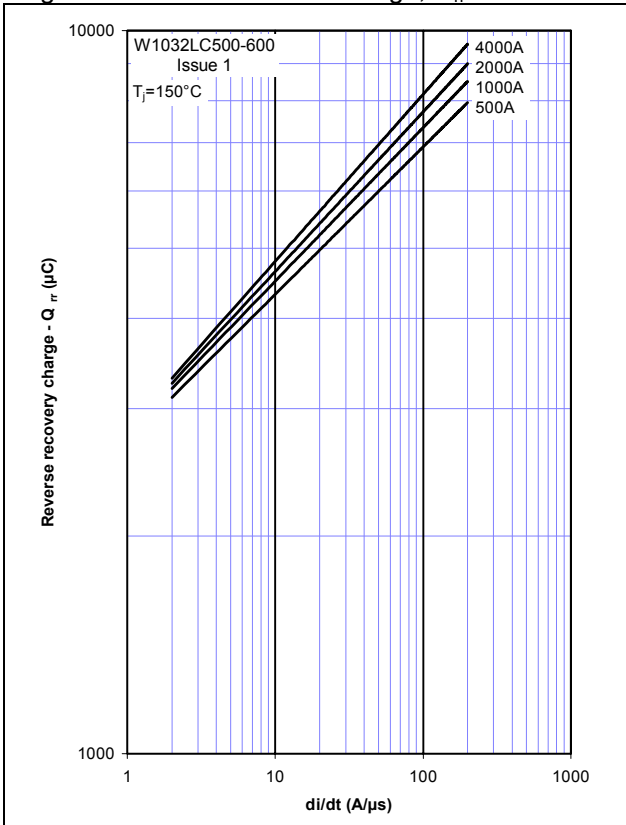

Figure 5 – Recovered charge (50% chord), Q_{ra}

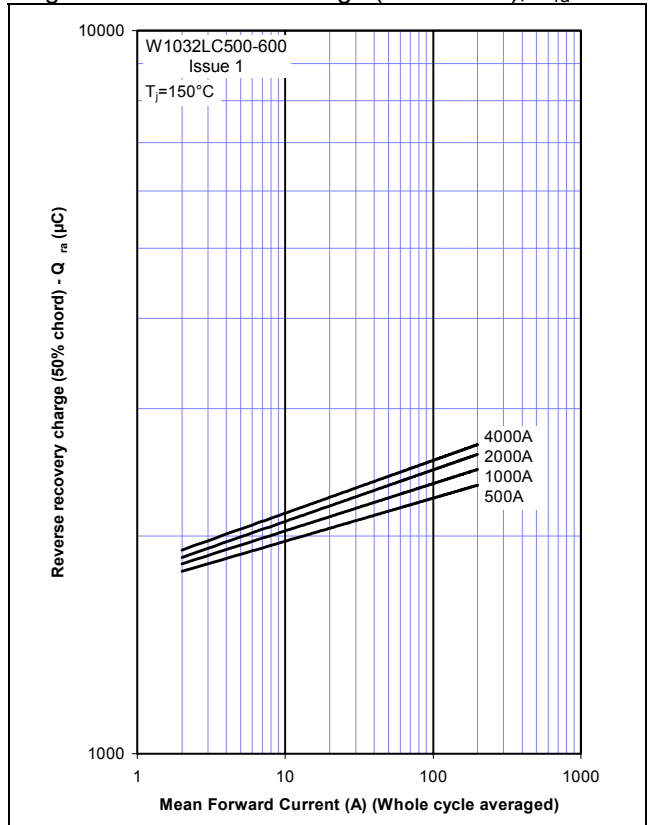

Figure 6 – Peak reverse recovery current, I_{rm}

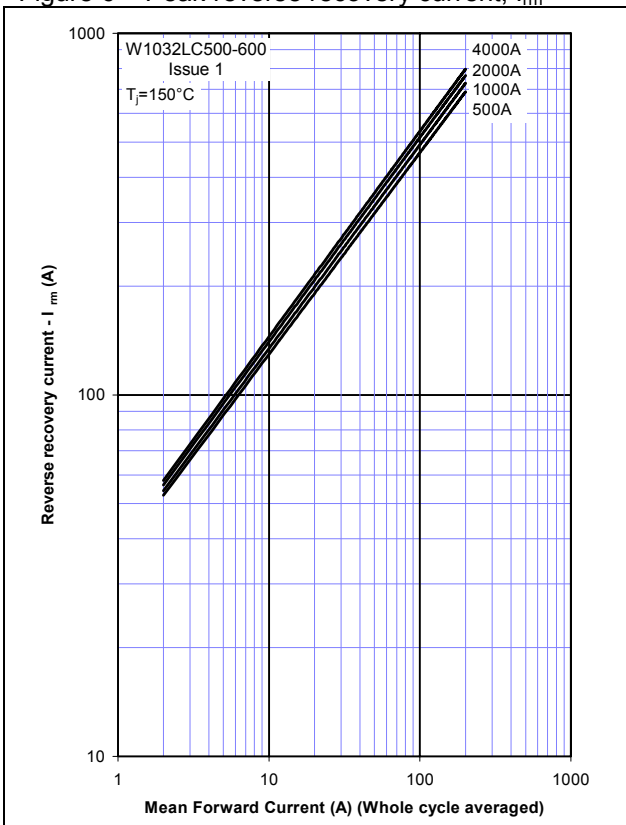

Figure 7 – Reverse recovery time (50% chord), t_{rr}

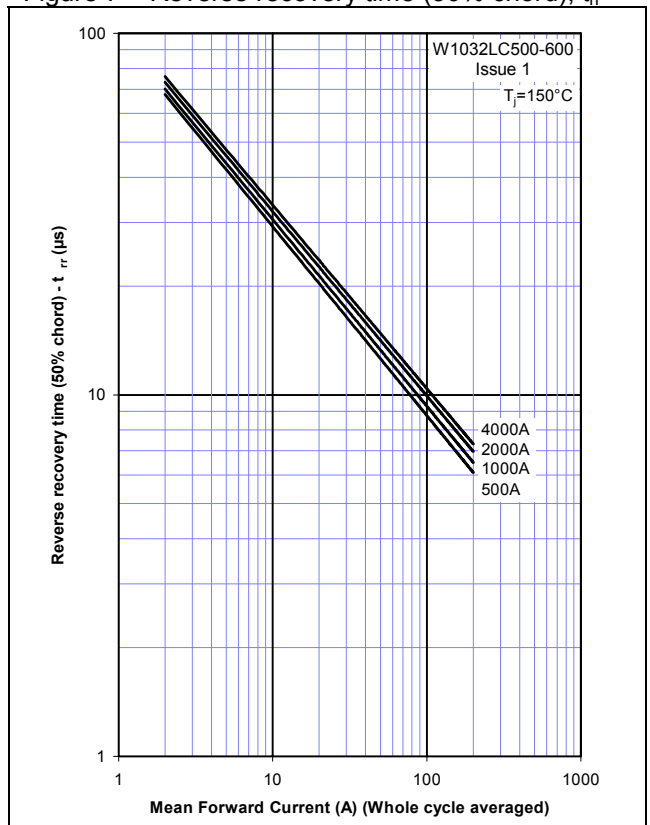

Figure 8 – Forward current vs. Power dissipation – Double Side Cooled

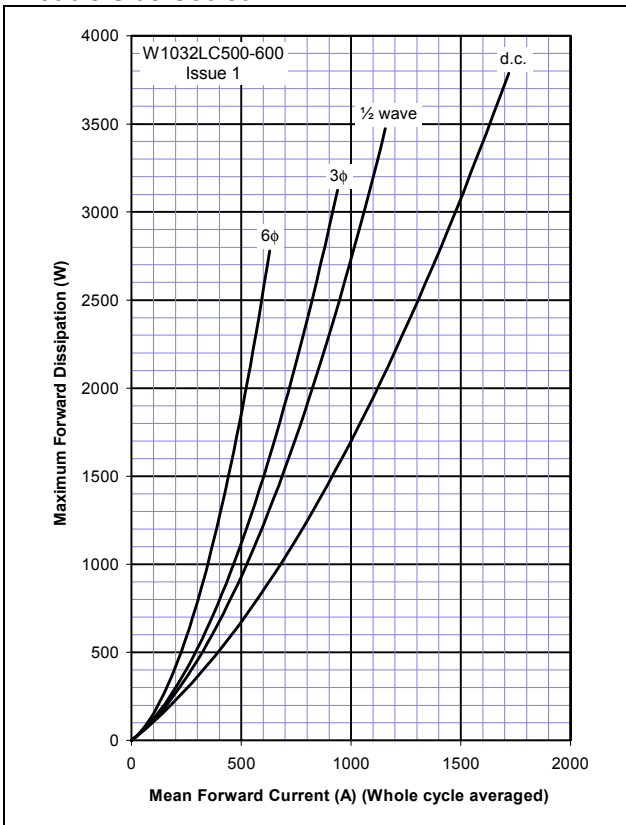

Figure 9 – Forward current vs. Heatsink temperature - Double Side Cooled

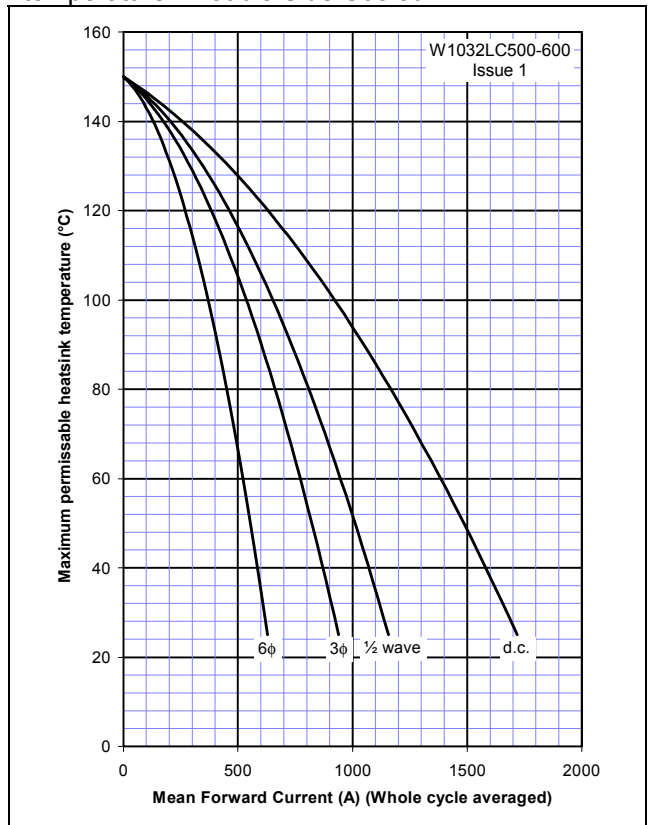

Figure 10 – Forward current vs. Power dissipation – Single Side Cooled

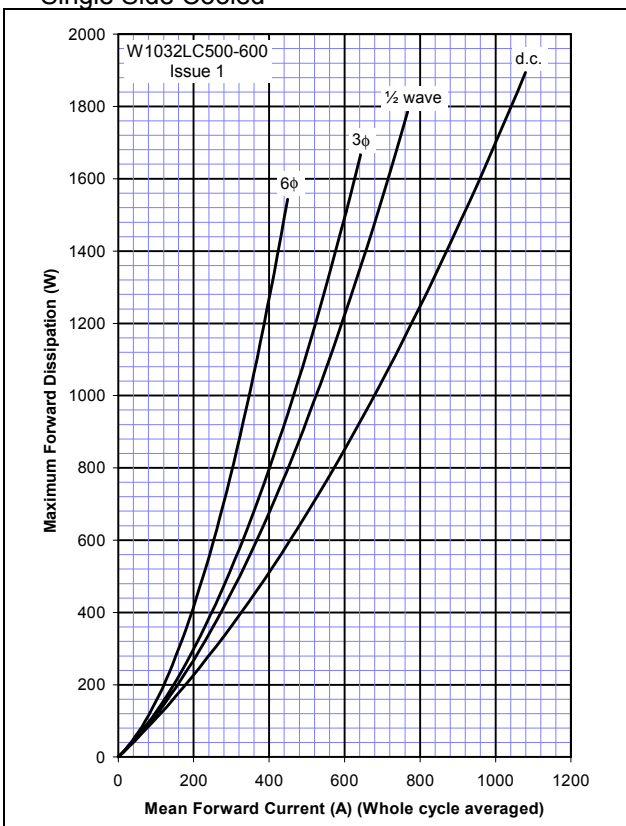
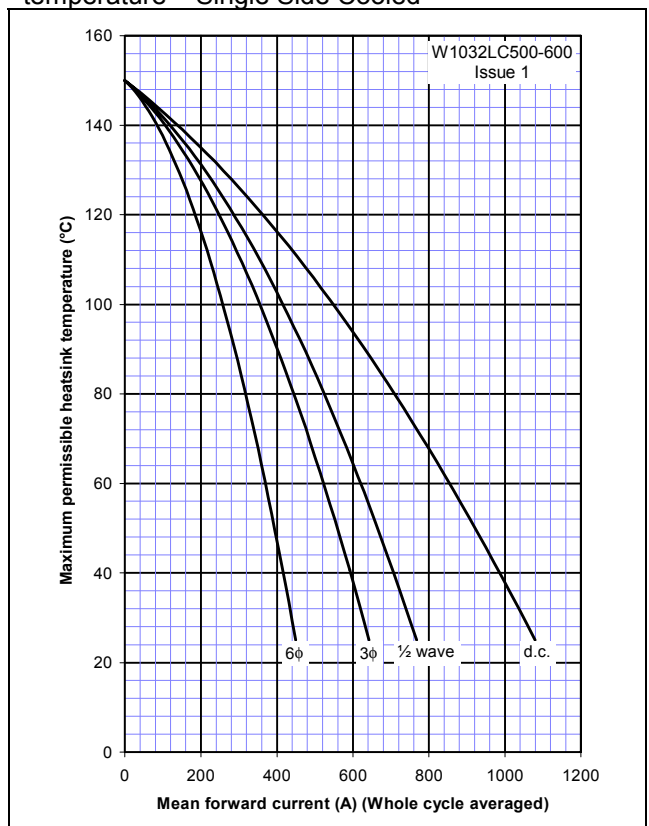
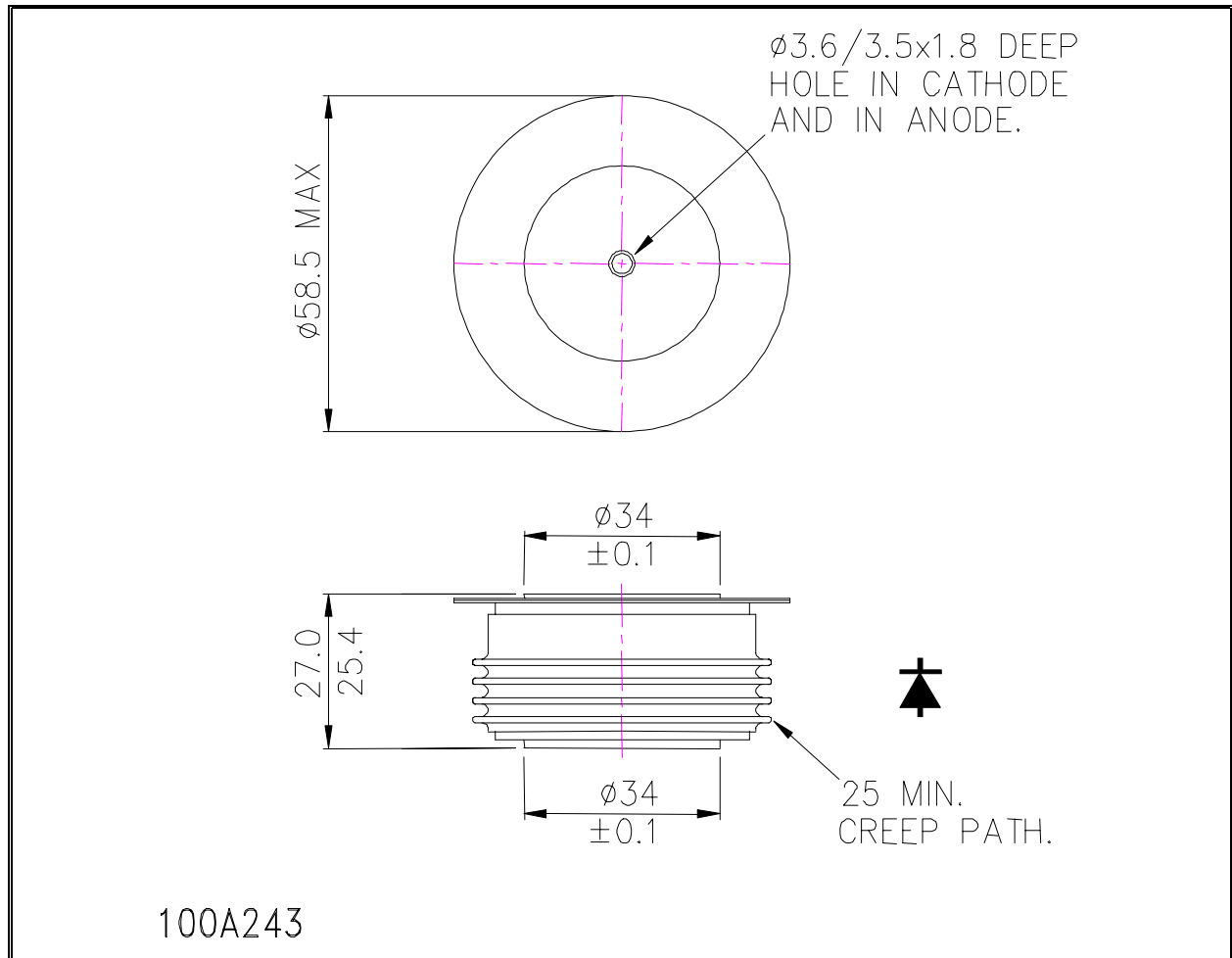

Figure 11 – Forward current vs. Heatsink temperature – Single Side Cooled



Outline Drawing & Ordering Information



100A243

ORDERING INFORMATION		(Please quote 10 digit code as below)	
W1032	LC	◆◆	0
Fixed Type Code	Fixed Outline Code	Voltage code $V_{DRM}/100$ 50-60	Fixed turn-off time code

Order code: W1032LC580 – 5800V V_{RRM} , 27mm clamp height capsule

IXYS Semiconductor GmbH
Edisonstraße 15
D-68623 Lampertheim
Tel: +49 6206 503-0
Fax: +49 6206 503-627
E-mail: marcom@ixys.de

WESTCODE
An IXYS Company

Westcode Semiconductors Ltd
Langley Park Way, Langley Park,
Chippenham, Wiltshire, SN15 1GE.
Tel: +44 (0)1249 444524
Fax: +44 (0)1249 659448
E-mail: WSL.sales@westcode.com

IXYS Corporation
3540 Bassett Street
Santa Clara CA 95054 USA
Tel: +1 (408) 982 0700
Fax: +1 (408) 496 0670
E-mail: sales@ixys.net

www.westcode.com

www.ixys.com

Westcode Semiconductors Inc
3270 Cherry Avenue
Long Beach CA 90807 USA
Tel: +1 (562) 595 6971
Fax: +1 (562) 595 8182
E-mail: WSI.sales@westcode.com

The information contained herein is confidential and is protected by Copyright. The information may not be used or disclosed except with the written permission of and in the manner permitted by the proprietors Westcode Semiconductors Ltd.

© Westcode Semiconductors Ltd.

In the interest of product improvement, Westcode reserves the right to change specifications at any time without prior notice.

Devices with a suffix code (2-letter, 3-letter or letter/digit/letter combination) added to their generic code are not necessarily subject to the conditions and limits contained in this report.