

**N****Datenblatt / Data sheet****Netz-Dioden-Modul  
Rectifier Diode Module****DD171N**Infineon Technologies Bipolar  
GmbH & Co. KG**DD171N  
ND171N****DD171N..K..-A****DD171N..K..-K****Elektrische Eigenschaften / Electrical properties**  
Höchstzulässige Werte / Maximum rated values

Periodische Spitzensperrspannung repetitive peak reverse voltages	$T_{vj} = -40^{\circ}\text{C} \dots T_{vj\text{max}}$	$V_{RRM}$	1200 1600	1400 1800	V V
Stoßspitzensperrspannung non-repetitive peak reverse voltage	$T_{vj} = +25^{\circ}\text{C} \dots T_{vj\text{max}}$	$V_{RSM}$	1300 1700	1500 1900	V V
Durchlaßstrom-Grenzeffektivwert maximum RMS on-state current		$I_{FRMSM}$		270	A
Dauergrenzstrom average on-state current	$T_C = 100^{\circ}\text{C}$	$I_{FAVM}$		171	A
Stoßstrom-Grenzwert surge current	$T_{vj} = 25^{\circ}\text{C}, t_p = 10\text{ ms}$ $T_{vj} = T_{vj\text{max}}, t_p = 10\text{ ms}$	$I_{FSM}$		6.600 5.600	A A
Grenzlastintegral $I^2t$ -value	$T_{vj} = 25^{\circ}\text{C}, t_p = 10\text{ ms}$ $T_{vj} = T_{vj\text{max}}, t_p = 10\text{ ms}$	$I^2t$		218.000 157.000	A <sup>2</sup> s A <sup>2</sup> s

## Charakteristische Werte / Characteristic values

Durchlaßspannung on-state voltage	$T_{vj} = T_{vj\text{max}}, I_F = 500\text{ A}$	$V_F$	max.	1,26	V
Schleusenspannung threshold voltage	$T_{vj} = T_{vj\text{max}}$	$V_{(TO)}$		0,75	V
Ersatzwiderstand slope resistance	$T_{vj} = T_{vj\text{max}}$	$r_T$		0,8	m $\Omega$
Sperrstrom reverse current	$T_{vj} = T_{vj\text{max}}, V_R = V_{RRM}$	$i_R$	max.	20	mA
Isolations-Prüfspannung insulation test voltage	RMS, $f = 50\text{ Hz}, t = 1\text{ sec}$ RMS, $f = 50\text{ Hz}, t = 1\text{ min}$	$V_{ISOL}$		3,0 2,5	kV kV

**Thermische Eigenschaften / Thermal properties**

Innerer Wärmewiderstand thermal resistance, junction to case	pro Modul / per Module, $\Theta = 180^{\circ}\text{ sin}$ pro Zweig / per arm, $\Theta = 180^{\circ}\text{ sin}$ pro Modul / per Module, DC pro Zweig / per arm, DC	$R_{thJC}$	max.	0,130 0,260 0,126 0,252	$^{\circ}\text{C/W}$ $^{\circ}\text{C/W}$ $^{\circ}\text{C/W}$ $^{\circ}\text{C/W}$
Übergangs-Wärmewiderstand thermal resistance, case to heatsink	pro Modul / per Module pro Zweig / per arm	$R_{thCH}$	max.	0,03 0,06	$^{\circ}\text{C/W}$ $^{\circ}\text{C/W}$
Höchstzulässige Sperrschichttemperatur maximum junction temperature		$T_{vj\text{max}}$		150	$^{\circ}\text{C}$
Betriebstemperatur operating temperature		$T_{c\text{op}}$		- 40...+150	$^{\circ}\text{C}$
Lagertemperatur storage temperature		$T_{\text{stg}}$		- 40...+150	$^{\circ}\text{C}$

prepared by:	A.Glunz	date of publication:	2016-01-28
approved by:	M.Leifeld	revision:	3.1

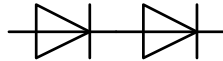
**N****Datenblatt / Data sheet****Netz-Dioden-Modul  
Rectifier Diode Module****DD171N**Infineon Technologies Bipolar  
GmbH & Co. KG**Mechanische Eigenschaften / Mechanical properties**

Gehäuse, siehe Anlage case, see annex			Seite 3 page 3	
Si-Element mit Druckkontakt Si-pellet with pressure contact				
Innere Isolation internal insulation			AIN	
Anzugsdrehmoment für mechanische Anschlüsse mounting torque	Toleranz ±15%	M1	6	Nm
Anzugsdrehmoment für elektrische Anschlüsse terminal connection torque	Toleranz ±10%	M2	6	Nm
Gewicht weight		G	typ. 310	g
Kriechstrecke creepage distance			15	mm
Schwingfestigkeit vibration resistance	f = 50 Hz		50	m/s <sup>2</sup>
	file-No.		E 83336	

**N**

# Datenblatt / Data sheet



Netz-Dioden-Modul  
Rectifier Diode Module

## DD171N

Infineon Technologies Bipolar  
GmbH & Co. KG

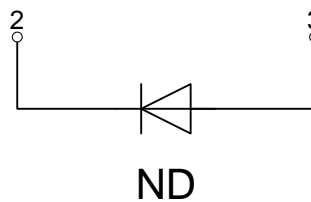
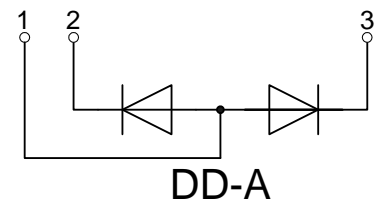
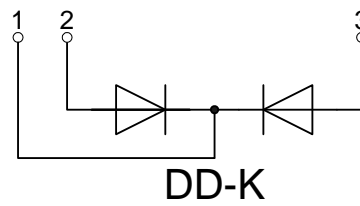
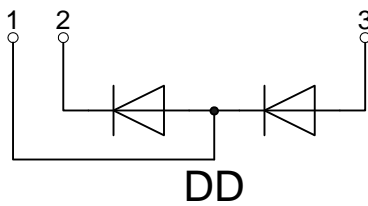
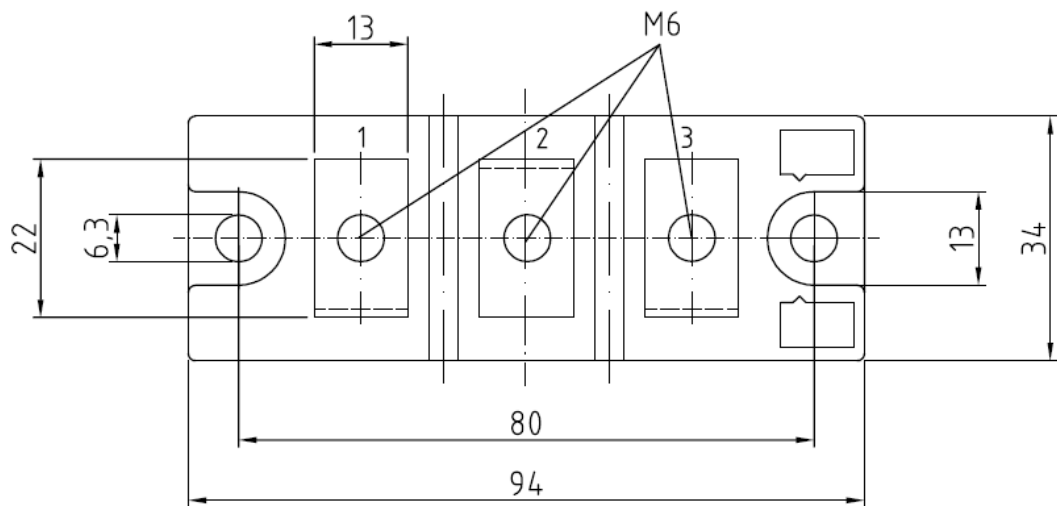
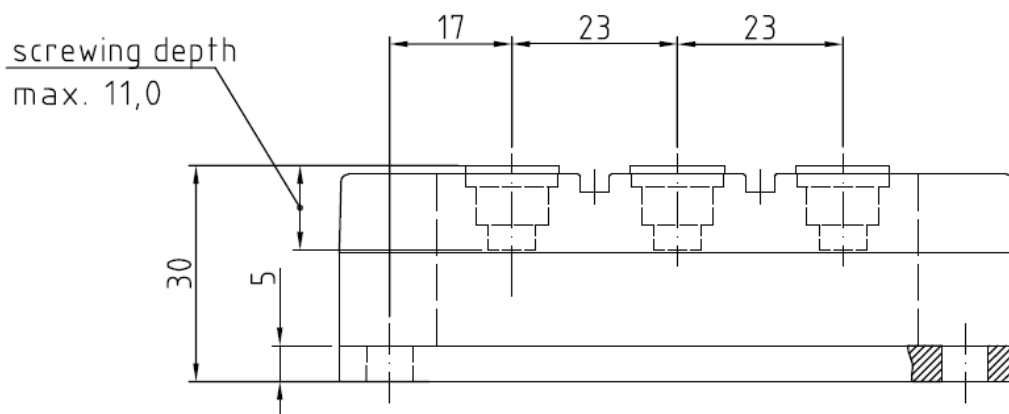



Analytische Elemente des transienten Wärmewiderstandes  $Z_{thJC}$  für DC  
Analytical elements of transient thermal impedance  $Z_{thJC}$  for DC

Pos. n	1	2	3	4	5	6	7
$R_{thn}$ [°C/W]	0,0094	0,0224	0,0586	0,162			
$T_n$ [s]	0,0014	0,0253	0,267	1,68			

Analytische Funktion / Analytical function:

$$Z_{thJC} = \sum_{n=1}^{n_{max}} R_{thn} \left( 1 - e^{-\frac{t}{T_n}} \right)$$

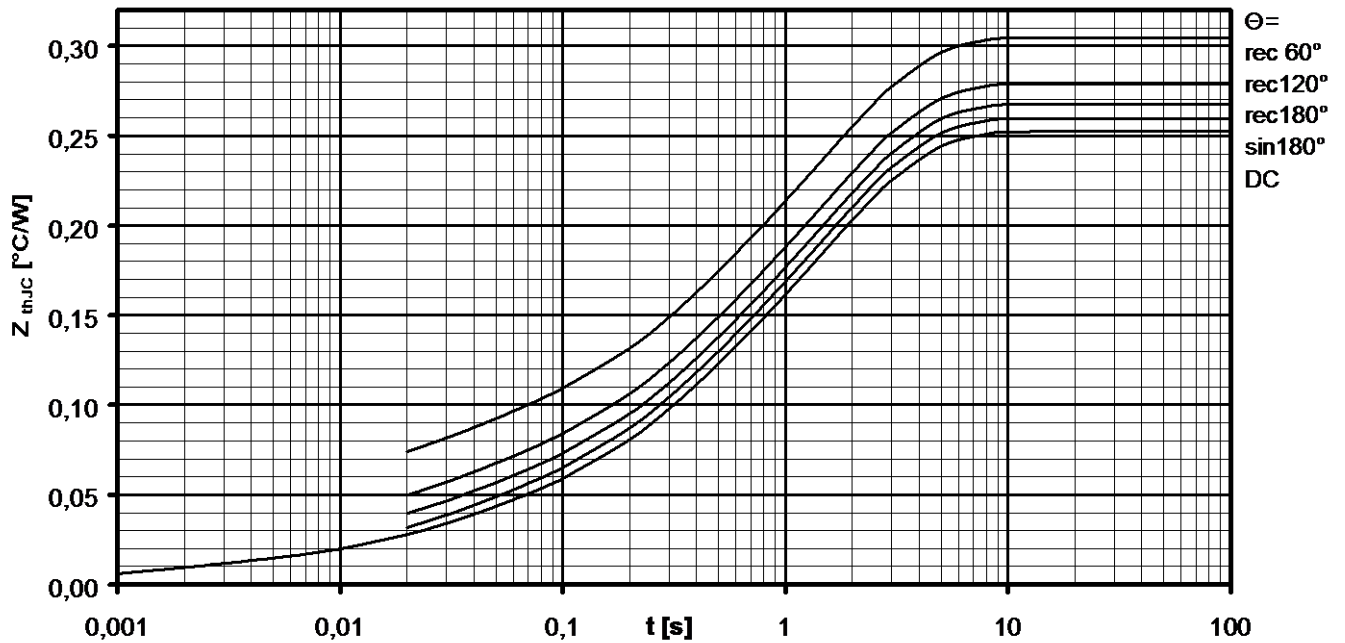

Transienter innerer Wärmewiderstand je Zweig / Transient thermal impedance per arm  $Z_{thJC} = f(t)$

Parameter: Stromflußwinkel  $\Theta$  / Current conduction angle  $\Theta$

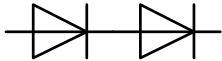

Natürliche Kühlung / Natural cooling  
 3 Module pro Kühler / 3 modules per heatsink  
 Kühler / Heatsink type: KM17 (60W)

**Analytische Elemente des transienten Wärmewiderstandes  $Z_{thCA}$**   
**Analytical elements of transient thermal impedance  $Z_{thCA}$**

Pos. n	1	2	3	4	5	6	7
$R_{thn}$ [°C/W]	0,0505	0,1235	1,616				
$T_n$ [s]	2,97	21,4	1180				

Verstärkte Kühlung / Forced cooling  
 3 Module pro Kühler / 3 modules per heatsink  
 Kühler / Heatsink type: KM17 (Papst 4650)

**Analytische Elemente des transienten Wärmewiderstandes  $Z_{thCA}$**   
**Analytical elements of transient thermal impedance  $Z_{thCA}$**

Pos. n	1	2	3	4	5	6	7
$R_{thn}$ [°C/W]	0,026	0,119	0,515				
$T_n$ [s]	2,41	13,6	354				

Analytische Funktion / Analytical function:

$$Z_{thCA} = \sum_{n=1}^{n_{max}} R_{thn} \left( 1 - e^{-\frac{t}{T_n}} \right)$$

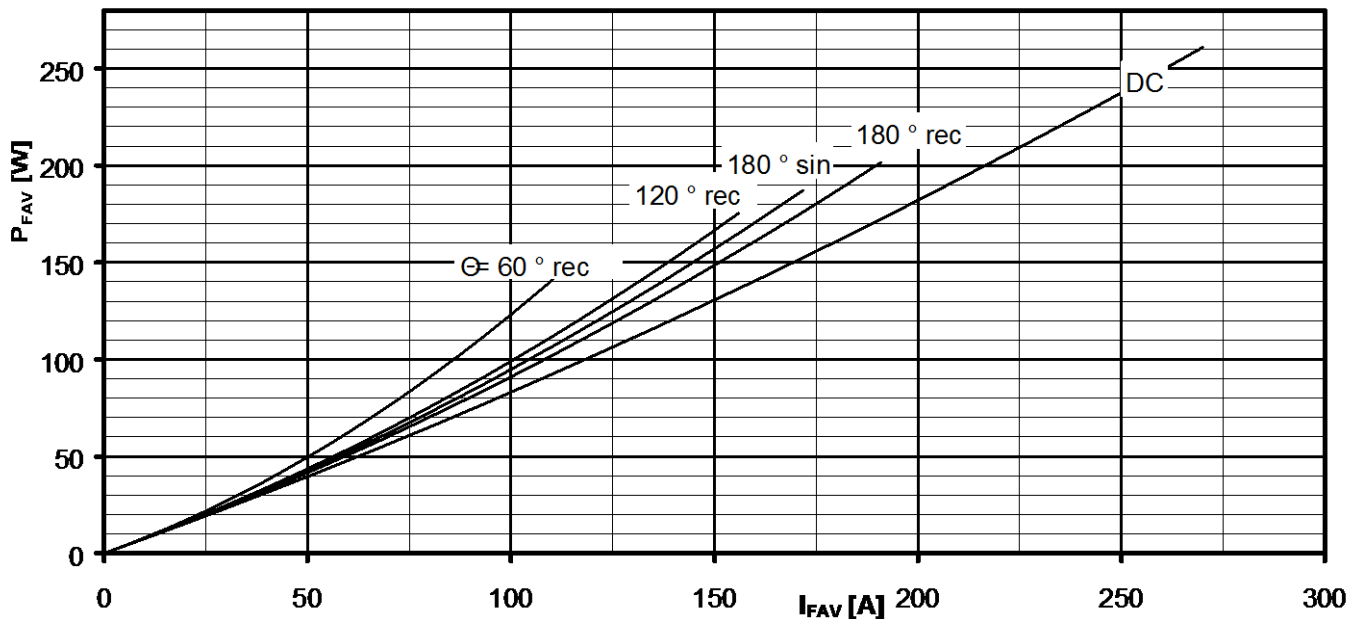
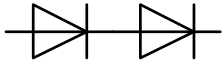

Durchlassverlustleistung je Zweig / On-state power loss per arm  $P_{FAV} = f(I_{FAV})$

Parameter: Stromflußwinkel / Current conduction angle  $\Theta$

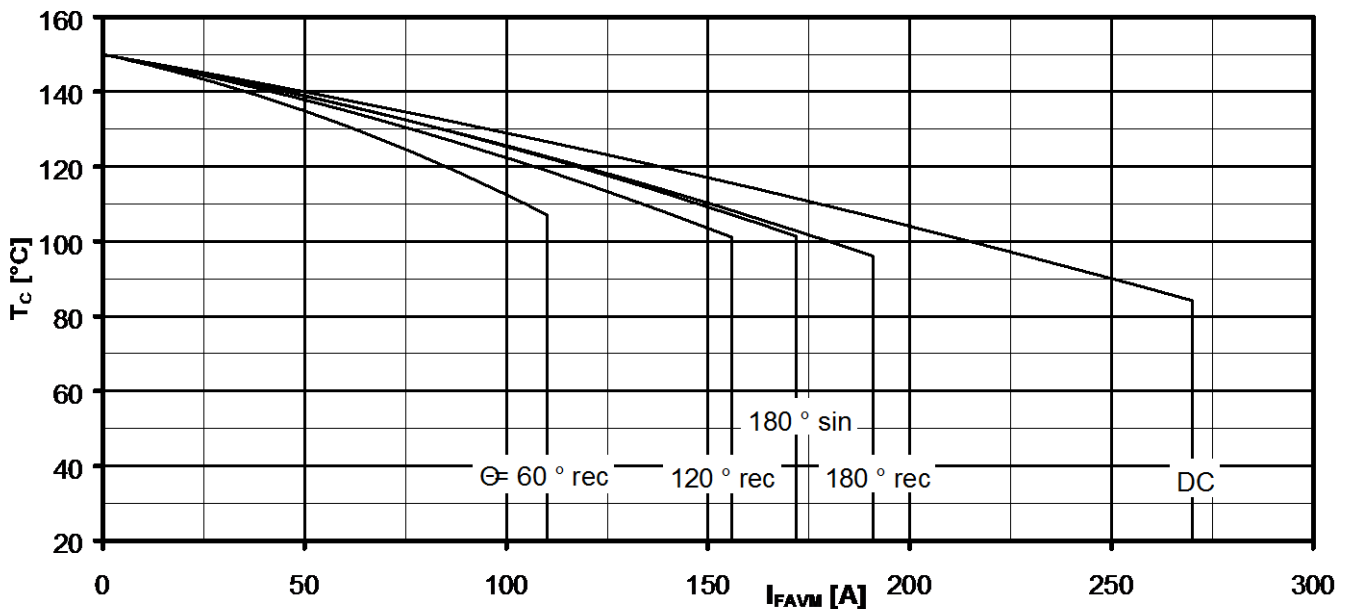

Höchstzulässige Gehäusetemperatur / Maximum allowable case temperature  $T_C = f(I_{FAVM})$

Strombelastung je Zweig / Current load per arm

Berechnungsgrundlage  $P_{TAV}$   
 Calculation base  $P_{TAV}$

Parameter: Stromflußwinkel  $\Theta$  / Current conduction angle  $\Theta$



Netz-Dioden-Modul  
Rectifier Diode Module

DD171N

Infineon Technologies Bipolar  
GmbH & Co. KG

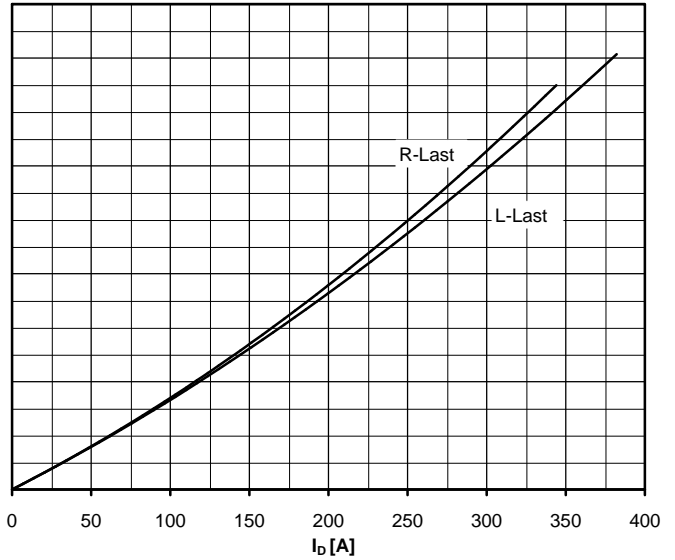
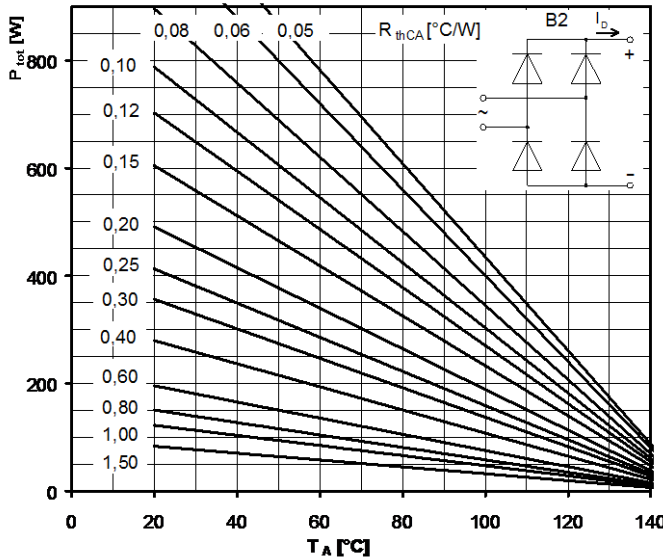

Höchstzulässiger Ausgangsstrom / Maximum rated output current  $I_D$

B2- Zweipuls-Brückenschaltung / Two-pulse bridge circuit

Gesamtverlustleistung der Schaltung / Total power dissipation at circuit  $P_{tot}$

Parameter:

Wärmewiderstand zwischen den Gehäusen und Umgebung / Thermal resistance cases to ambient  $R_{thCA}$

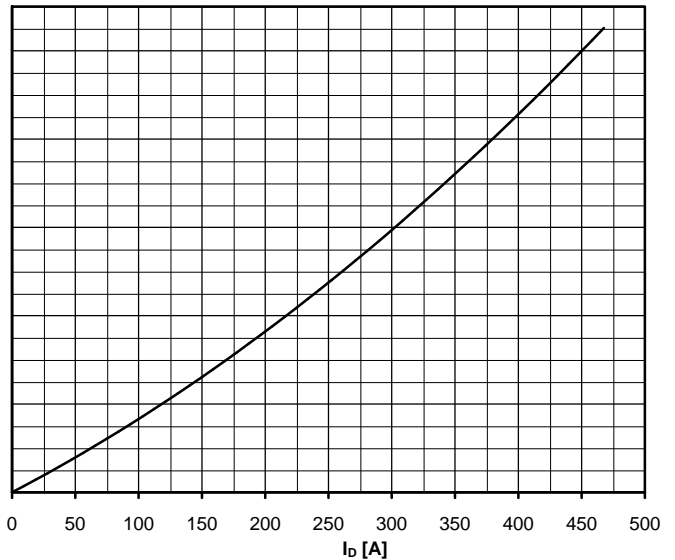
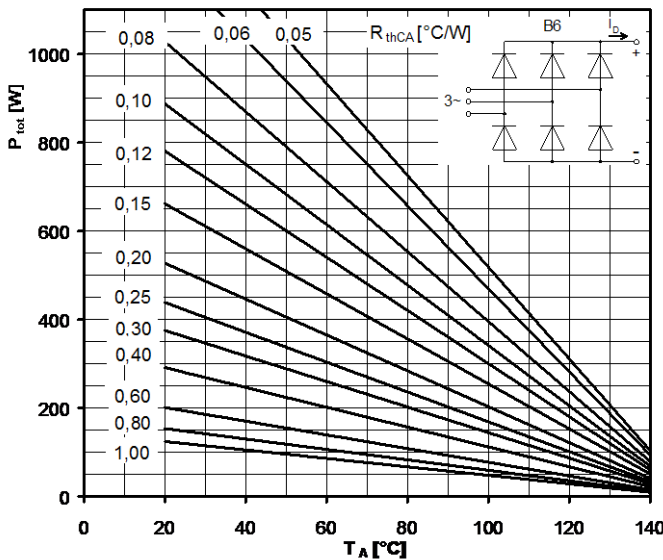

Höchstzulässiger Ausgangsstrom / Maximum rated output current  $I_D$

B6- Sechspuls-Brückenschaltung / Six-pulse bridge circuit

Gesamtverlustleistung der Schaltung / Total power dissipation at circuit  $P_{tot}$

Parameter:

Wärmewiderstand zwischen den Gehäusen und Umgebung / Thermal resistance cases to ambient  $R_{thCA}$

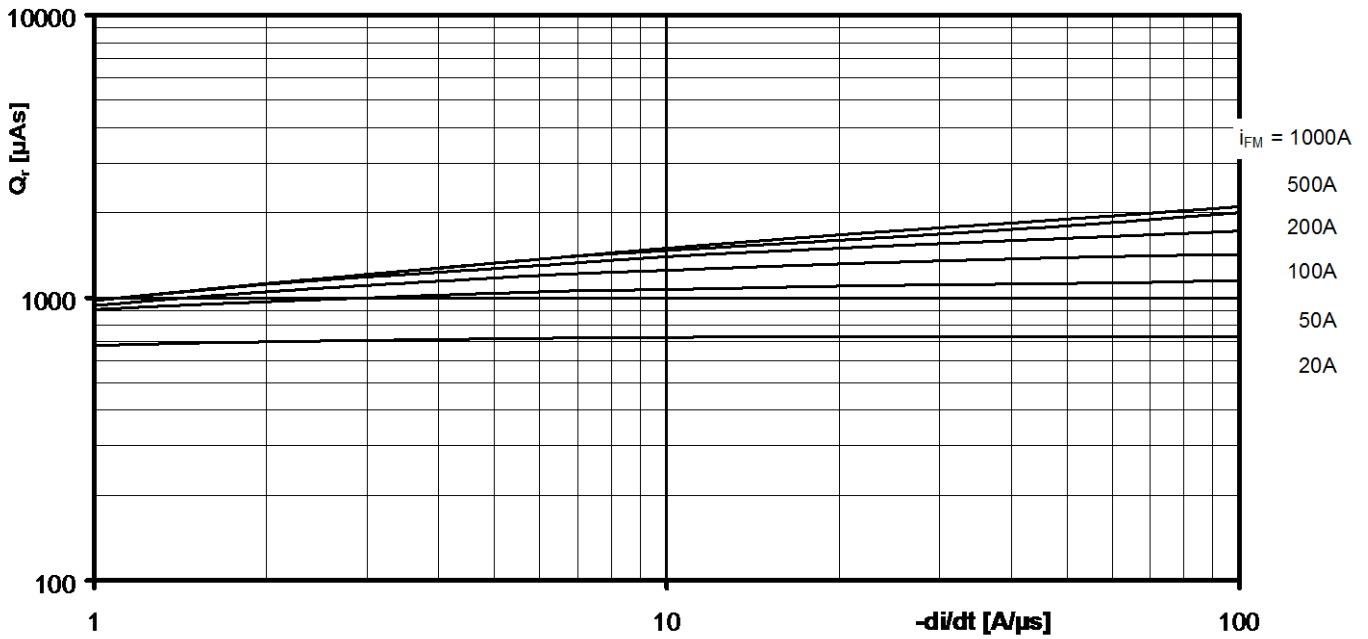

Sperrverzögerungsladung / Recovered charge  $Q_r = f(-di/dt)$

$$T_{vj} = T_{vjmax}, V_R \leq 0,5 V_{RRM}, V_{RM} = 0,8 V_{RRM}$$

Parameter: Durchlaßstrom / On-state current  $i_{FM}$

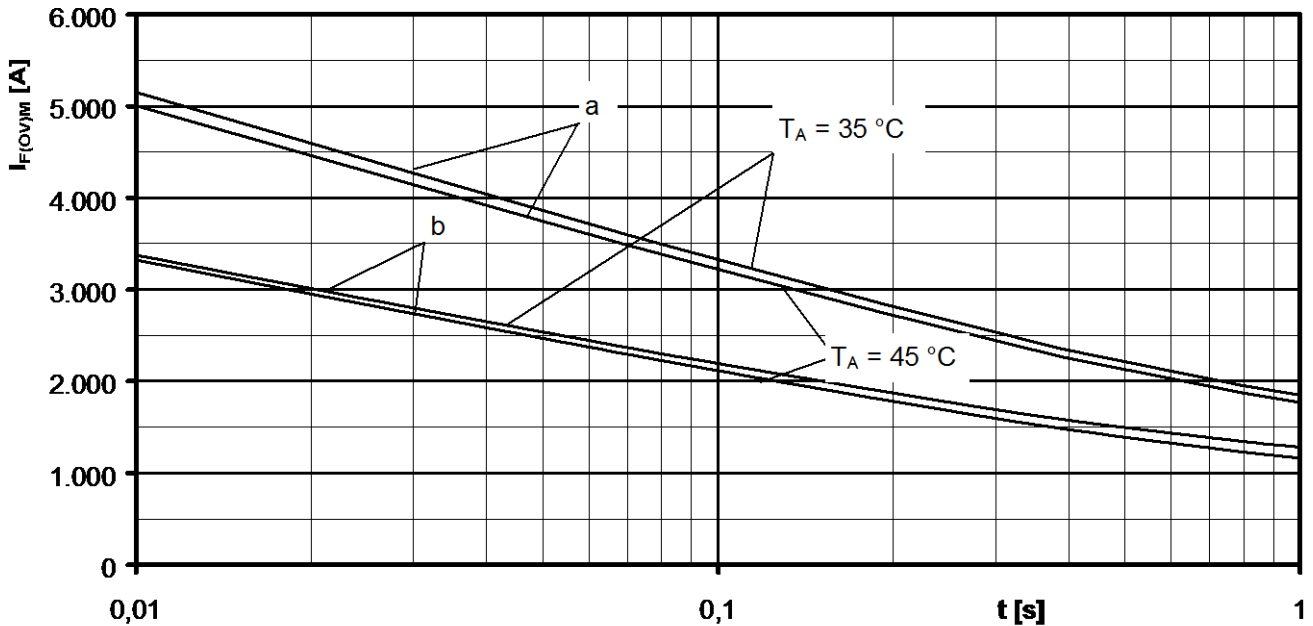

Grenzstrom je Zweig / Maximum overload on-state current per arm  $I_{F(OV)M} = f(t), V_{RM} = 0,8 V_{RRM}$

a: Leerlauf / No-load conditions

b: Vorlaststrom je Zweig / Pre-load current per arm  $I_{FAV(vor)} = I_{FAVM}$

$T_a = 35^\circ\text{C}$ , verstärkte Luftkühlung / Forced air cooling    Kühlkörper / Heatsink type: KM17 (Papst 4650)

$T_a = 45^\circ\text{C}$ , natürliche Luftkühlung / Natural air cooling    Kühlkörper / Heatsink type: KM17 (60W)



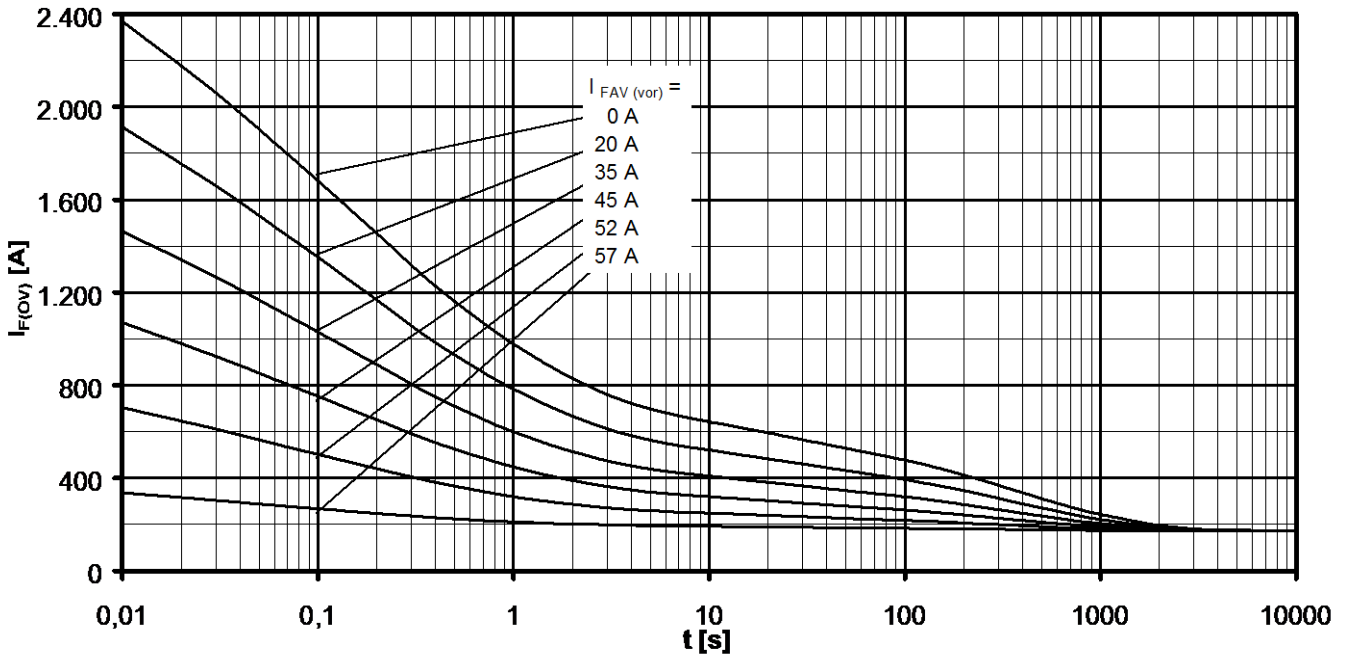

Überstrom je Zweig / Overload on-state current  $I_{F(ov)}$

B6- Sechspuls-Brückenschaltung, 120° Rechteck / Six-pulse bridge circuit, 120° rectangular

Kühlkörper / Heatsink type KM17 (60W) Natürliche Kühlung bei / Natural cooling at  $T_A = 45^\circ\text{C}$

Parameter: Vorlaststrom je Zweig / Pre-load current per arm  $I_{FAV(vor)}$

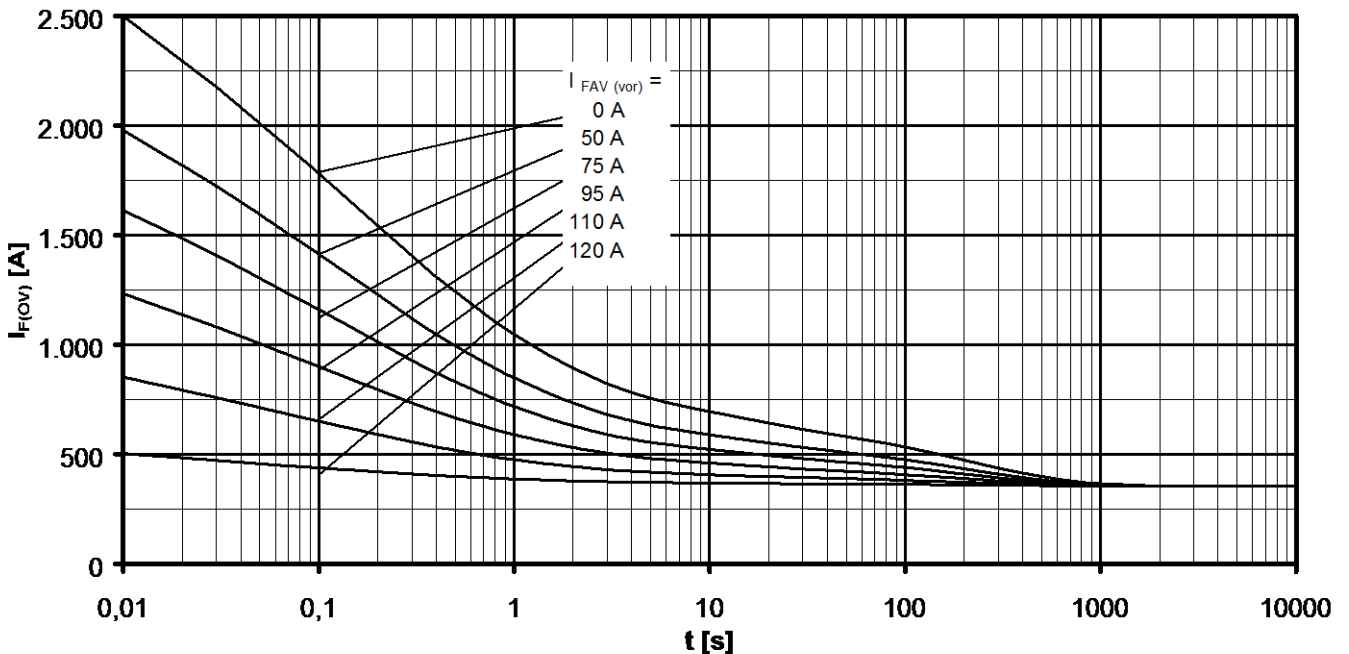

Überstrom je Zweig / Overload on-state current  $I_{F(ov)}$

B6- Sechspuls-Brückenschaltung, 120° Rechteck / Six-pulse bridge circuit 120° rectangular

Kühlkörper / Heatsink type KM17 (Papst 4650) Verstärkte Kühlung bei / Forced cooling at  $T_A = 35^\circ\text{C}$

Parameter: Vorlaststrom je Zweig / Pre-load current per arm  $I_{FAV(vor)}$

# Mouser Electronics

Authorized Distributor

Click to View Pricing, Inventory, Delivery & Lifecycle Information:

[Infineon:](#)

[ND171N18K](#) [DD171N16K](#) [DD171N12K](#) [ND171N16K](#) [ND171N12K](#)