

# Standard Rectifier Module

$V_{RRM} = 2 \times 1200 \text{ V}$   
 $I_{FAV} = 300 \text{ A}$   
 $V_F = 1 \text{ V}$

Phase leg

Part number

**MDD310-12N1**

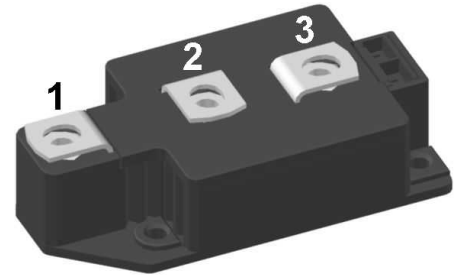

Backside: isolated

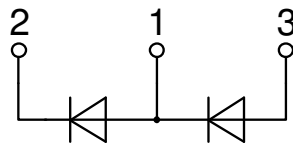
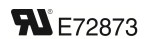

### Features / Advantages:

- Package with DCB ceramic
- Improved temperature and power cycling
- Planar passivated chips
- Very low forward voltage drop
- Very low leakage current

### Applications:

- Diode for main rectification
- For single and three phase bridge configurations
- Supplies for DC power equipment
- Input rectifiers for PWM inverter
- Battery DC power supplies
- Field supply for DC motors

### Package: Y2

- Isolation Voltage: 3600 V~
- Industry standard outline
- RoHS compliant
- Height: 30 mm
- Base plate: DCB ceramic
- Reduced weight
- Advanced power cycling

### Terms Conditions of usage:

The data contained in this product data sheet is exclusively intended for technically trained staff. The user will have to evaluate the suitability of the product for the intended application and the completeness of the product data with respect to his application. The specifications of our components may not be considered as an assurance of component characteristics. The information in the valid application- and assembly notes must be considered. Should you require product information in excess of the data given in this product data sheet or which concerns the specific application of your product, please contact your local sales office.

Due to technical requirements our product may contain dangerous substances. For information on the types in question please contact your local sales office.

Should you intend to use the product in aviation, in health or life endangering or life support applications, please notify. For any such application we urgently recommend

- to perform joint risk and quality assessments;

- the conclusion of quality agreements;

- to establish joint measures of an ongoing product survey, and that we may make delivery dependent on the realization of any such measures.

Rectifier				Ratings			
Symbol	Definition	Conditions	min.	typ.	max.	Unit	
$V_{RSM}$	max. non-repetitive reverse blocking voltage	$T_{VJ} = 25^{\circ}C$			1300	V	
$V_{RRM}$	max. repetitive reverse blocking voltage	$T_{VJ} = 25^{\circ}C$			1200	V	
$I_R$	reverse current	$V_R = 1200\text{ V}$	$T_{VJ} = 25^{\circ}C$		1	mA	
		$V_R = 1200\text{ V}$	$T_{VJ} = 150^{\circ}C$		20	mA	
$V_F$	forward voltage drop	$I_F = 300\text{ A}$	$T_{VJ} = 25^{\circ}C$		1.13	V	
		$I_F = 600\text{ A}$			1.33	V	
		$I_F = 300\text{ A}$	$T_{VJ} = 125^{\circ}C$			1.00	V
		$I_F = 600\text{ A}$				1.29	V
$I_{FAV}$	average forward current	$T_C = 100^{\circ}C$	$T_{VJ} = 150^{\circ}C$		300	A	
$I_{F(RMS)}$	RMS forward current	180° sine			480	A	
$V_{F0}$	threshold voltage	} for power loss calculation only	$T_{VJ} = 150^{\circ}C$		0.75	V	
$r_F$	slope resistance				0.63	mΩ	
$R_{thJC}$	thermal resistance junction to case				0.13	K/W	
$R_{thCH}$	thermal resistance case to heatsink			0.04		K/W	
$P_{tot}$	total power dissipation		$T_C = 25^{\circ}C$		960	W	
$I_{FSM}$	max. forward surge current	$t = 10\text{ ms}; (50\text{ Hz}), \text{ sine}$	$T_{VJ} = 45^{\circ}C$		11.5	kA	
		$t = 8,3\text{ ms}; (60\text{ Hz}), \text{ sine}$	$V_R = 0\text{ V}$		12.4	kA	
		$t = 10\text{ ms}; (50\text{ Hz}), \text{ sine}$	$T_{VJ} = 150^{\circ}C$		9.78	kA	
		$t = 8,3\text{ ms}; (60\text{ Hz}), \text{ sine}$	$V_R = 0\text{ V}$		10.6	kA	
$I^2t$	value for fusing	$t = 10\text{ ms}; (50\text{ Hz}), \text{ sine}$	$T_{VJ} = 45^{\circ}C$		661.3	kA <sup>2</sup> s	
		$t = 8,3\text{ ms}; (60\text{ Hz}), \text{ sine}$	$V_R = 0\text{ V}$		641.7	kA <sup>2</sup> s	
		$t = 10\text{ ms}; (50\text{ Hz}), \text{ sine}$	$T_{VJ} = 150^{\circ}C$		477.8	kA <sup>2</sup> s	
		$t = 8,3\text{ ms}; (60\text{ Hz}), \text{ sine}$	$V_R = 0\text{ V}$		463.5	kA <sup>2</sup> s	
$C_J$	junction capacitance	$V_R = 400\text{ V}; f = 1\text{ MHz}$	$T_{VJ} = 25^{\circ}C$		381	pF	

Package Y2				Ratings			
Symbol	Definition	Conditions	min.	typ.	max.	Unit	
$I_{RMS}$	RMS current	per terminal			600	A	
$T_{VJ}$	virtual junction temperature		-40		150	°C	
$T_{op}$	operation temperature		-40		125	°C	
$T_{stg}$	storage temperature		-40		125	°C	
<b>Weight</b>					254	g	
$M_D$	mounting torque		2.5		5	Nm	
$M_T$	terminal torque		12		15	Nm	
$d_{Spp/App}$	creepage distance on surface   striking distance through air	terminal to terminal	13.0			mm	
$d_{Spb/Apb}$		terminal to backside	13.0			mm	
$V_{ISOL}$	isolation voltage	t = 1 second	3600			V	
		t = 1 minute	3000			V	

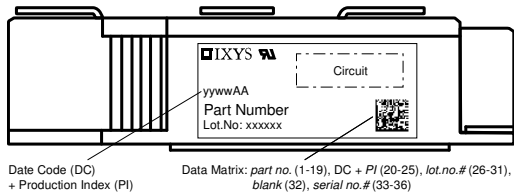

Ordering	Ordering Number	Marking on Product	Delivery Mode	Quantity	Code No.
Standard	MDD310-12N1	MDD310-12N1	Box	2	429155

### Equivalent Circuits for Simulation

\* on die level

$T_{VJ} = 150\text{ }^{\circ}\text{C}$

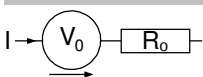

Rectifier

$V_{0\text{ max}}$	threshold voltage	0.75	V
$R_{0\text{ max}}$	slope resistance *	0.4	mΩ

Outlines Y2

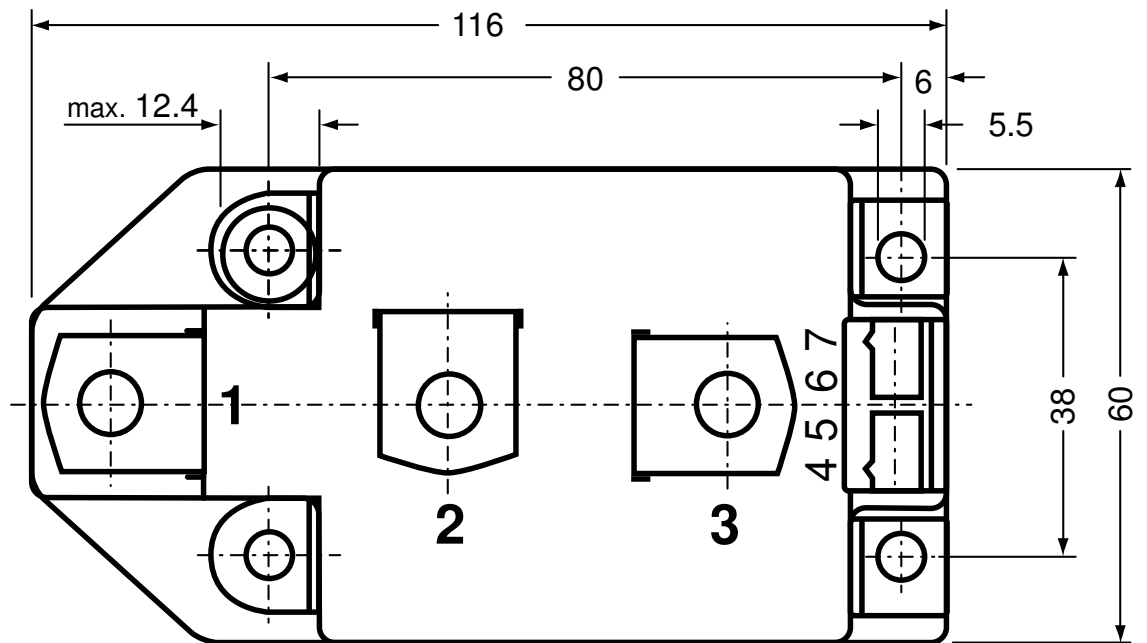
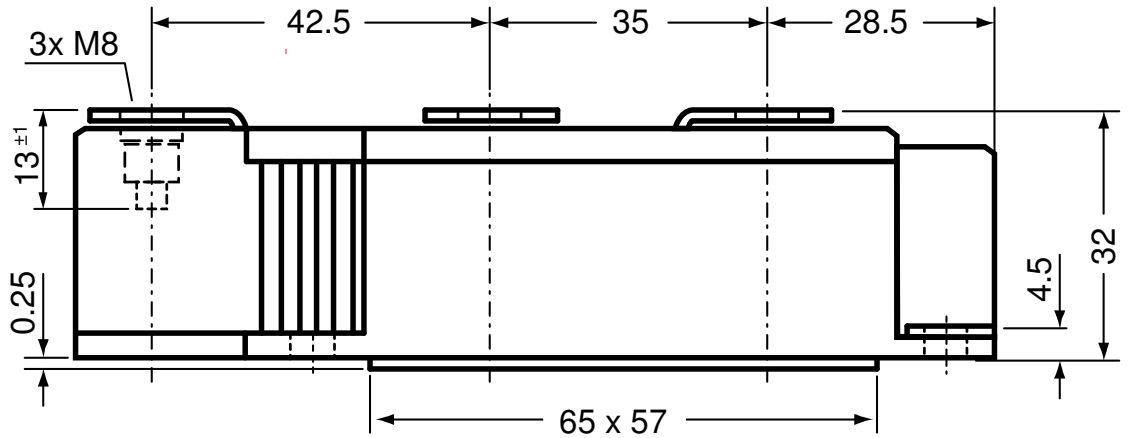

**Rectifier**

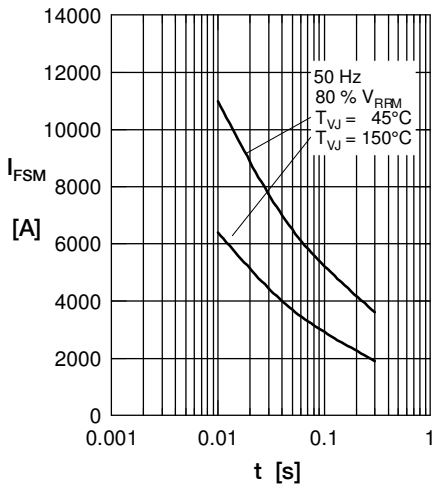

Fig. 1 Surge overload current  
 $I_{FSM}$ : Crest value,  $t$ : duration

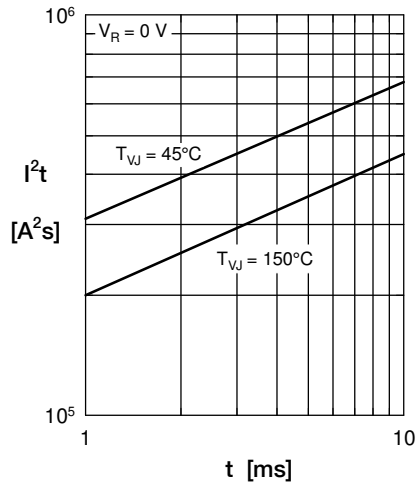

Fig. 2  $I^2t$  versus time (1-10 ms)

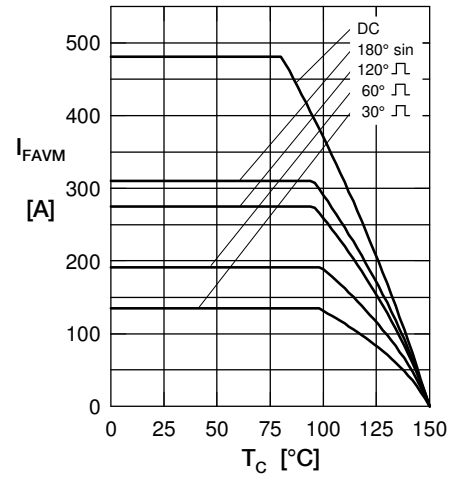

Fig. 3 Maximum forward current at case temperature

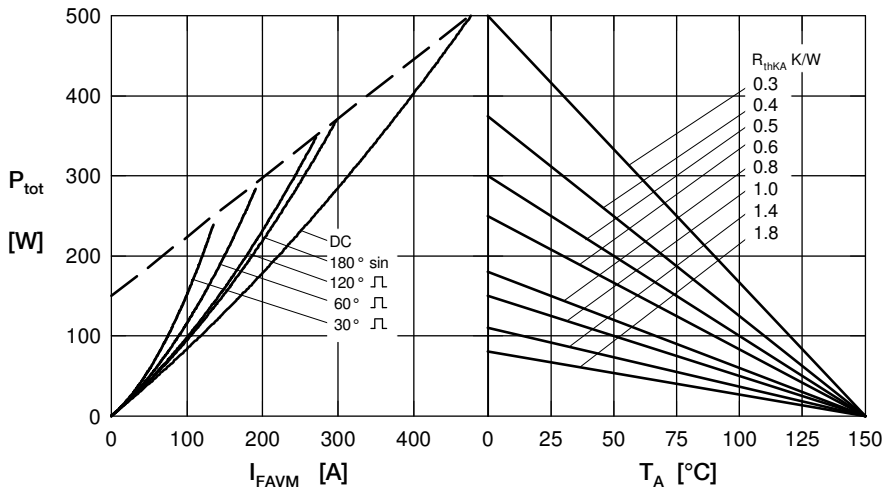

Fig. 4 Power dissipation versus forward current and ambient temperature (per diode)

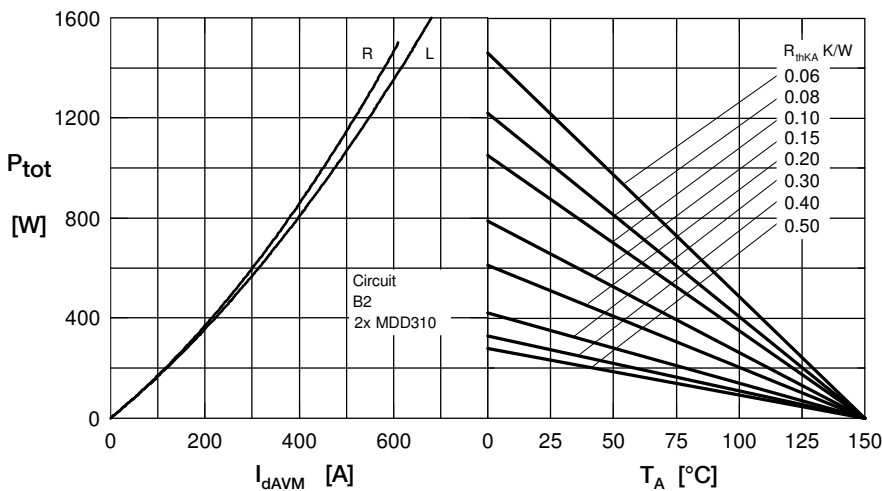

Fig. 5 Single phase rectifier bridge: Power dissipation vs. direct output current and ambient temperature  $R$  = resistive load,  $L$  = inductive load

**Rectifier**

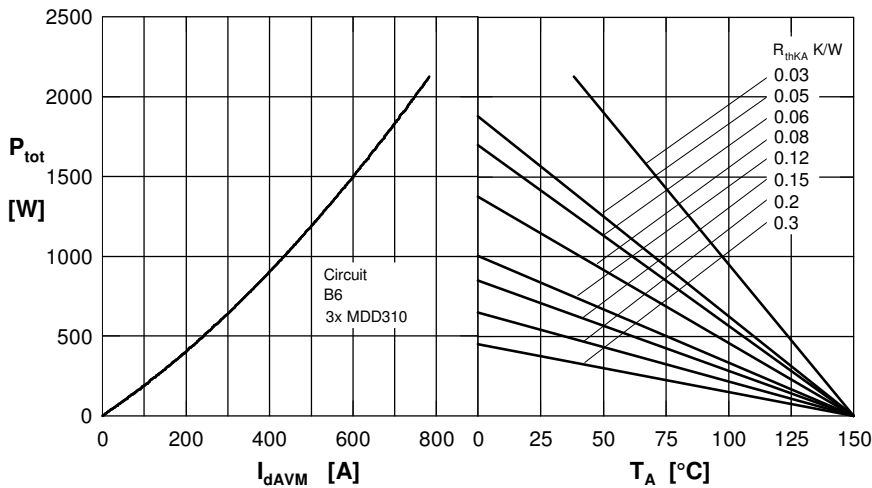

Fig.6 Three phase rectifier bridge: Power dissipation versus direct output current and ambient temperature

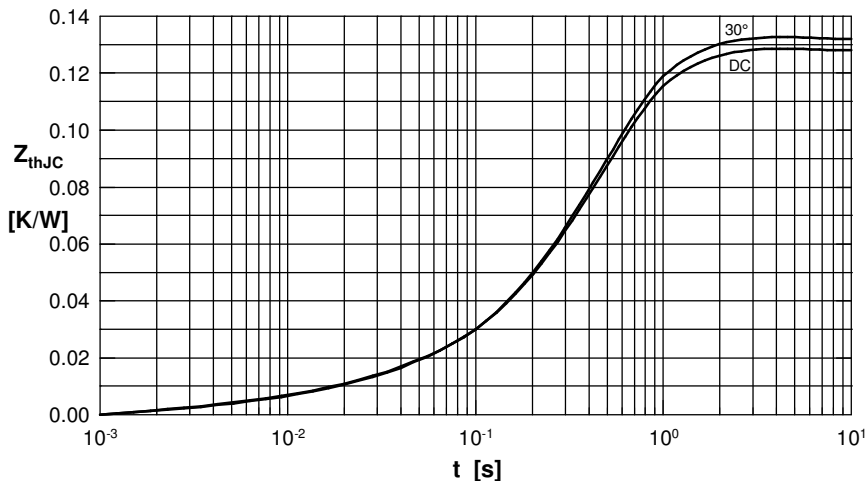

Fig. 7 Transient thermal impedance junction to case (per diode)

$R_{thJC}$  for various conduction angles  $d$ .

$d$	$R_{thJC}$ [K/W]
DC	0.129
180°	0.131
120°	0.132
60°	0.132
30°	0.133

Constants for  $Z_{thJC}$  calculation:

$i$	$R_{thi}$ [K/W]	$t_i$ [s]
1	0.0035	0.0099
2	0.0165	0.1680
3	0.1091	0.4560

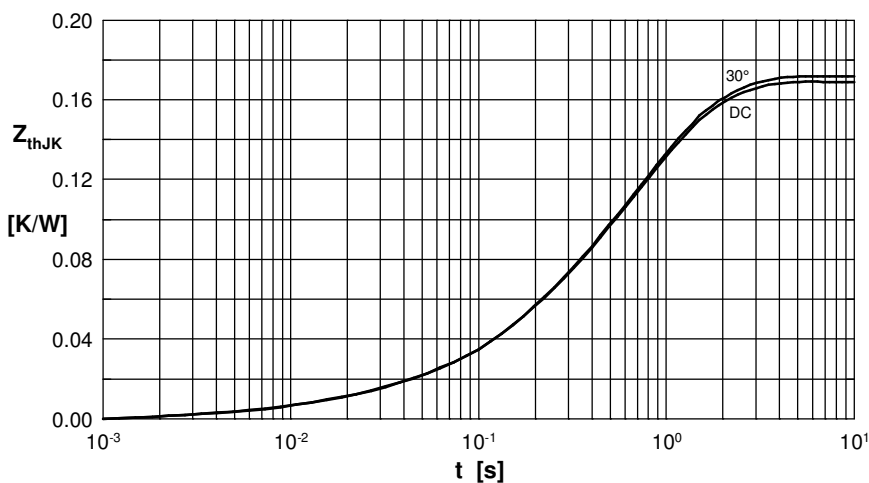

Fig. 8 Transient thermal impedance junction to heatsink (per diode)

$R_{thJK}$  for various conduction angles  $d$ .

$d$	$R_{thJK}$ [K/W]
DC	0.169
180°	0.171
120°	0.172
60°	0.172
30°	0.173

Constants for  $Z_{thJK}$  calculation:

$i$	$R_{thi}$ (K/W)	$t_i$ (s)
1	0.0035	0.0099
2	0.0165	0.1680
3	0.1091	0.4560
4	0.0400	1.3600