

Standard Rectifier Module

3~ Rectifier
$V_{RRM} = 1600\text{ V}$
$I_{DAV} = 450\text{ A}$
$I_{FSM} = 2400\text{ A}$

3~ Rectifier Bridge + NTC

Part number

MDMA450U1600PTEH

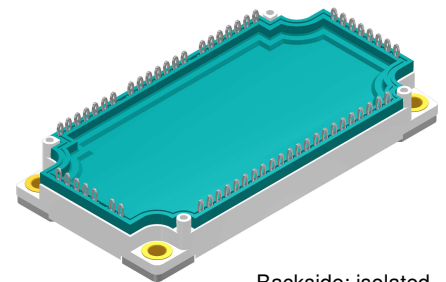

Backside: isolated

E72873

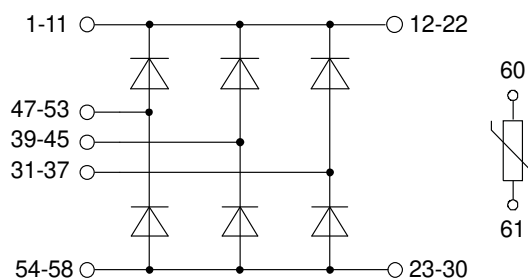

Features / Advantages:

- Package with DCB ceramic
- Improved temperature and power cycling
- Planar passivated chips
- Very low forward voltage drop
- Very low leakage current

Applications:

- Diode for main rectification
- For three phase bridge configurations
- Supplies for DC power equipment
- Input rectifiers for PWM inverter
- Battery DC power supplies
- Field supply for DC motors

Package: E3-Pack

- Isolation Voltage: 3600 V~
- Industry standard outline
- RoHS compliant
- PressFit-Pins for PCB mounting
- Height: 17 mm
- Base plate: Copper internally DCB isolated
- Advanced power cycling
- Phase Change Material available

Terms and Conditions of Usage

The data contained in this product data sheet is exclusively intended for technically trained staff. The user will have to evaluate the suitability of the product for the intended application and the completeness of the product data with respect to his application. The specifications of our components may not be considered as an assurance of component characteristics. The information in the valid application- and assembly notes must be considered. Should you require product information in excess of the data given in this product data sheet or which concerns the specific application of your product, please contact your local sales office.

Due to technical requirements our product may contain dangerous substances. For information on the types in question please contact your local sales office.

Should you intend to use the product in aviation, in health or life endangering or life support applications, please notify. For any such application we urgently recommend

- to perform joint risk and quality assessments;

- the conclusion of quality agreements;

- to establish joint measures of an ongoing product survey, and that we may make delivery dependent on the realization of any such measures.

Rectifier				Ratings			
Symbol	Definition	Conditions		min.	typ.	max.	Unit
V_{RSM}	max. non-repetitive reverse blocking voltage			$T_{VJ} = 25^{\circ}C$		1700	V
V_{RRM}	max. repetitive reverse blocking voltage			$T_{VJ} = 25^{\circ}C$		1600	V
I_R	reverse current	$V_R = 1600$ V		$T_{VJ} = 25^{\circ}C$		100	μA
		$V_R = 1600$ V		$T_{VJ} = 150^{\circ}C$		3	mA
V_F	forward voltage drop	$I_F = 150$ A		$T_{VJ} = 25^{\circ}C$		1.24	V
		$I_F = 450$ A				1.76	V
		$I_F = 150$ A		$T_{VJ} = 125^{\circ}C$		1.20	V
		$I_F = 450$ A				1.91	V
I_{DAV}	bridge output current	$T_C = 85^{\circ}C$	rectangular	$T_{VJ} = 150^{\circ}C$		450	A
V_{FO}	threshold voltage	} for power loss calculation only		$T_{VJ} = 150^{\circ}C$		0.82	V
r_F	slope resistance					2.5	m Ω
R_{thJC}	thermal resistance junction to case					0.2	K/W
R_{thCH}	thermal resistance case to heatsink				0.1		K/W
P_{tot}	total power dissipation			$T_C = 25^{\circ}C$		625	W
I_{FSM}	max. forward surge current	$t = 10$ ms; (50 Hz), sine		$T_{VJ} = 45^{\circ}C$		2.40	kA
		$t = 8,3$ ms; (60 Hz), sine		$V_R = 0$ V		2.59	kA
		$t = 10$ ms; (50 Hz), sine		$T_{VJ} = 150^{\circ}C$		2.04	kA
		$t = 8,3$ ms; (60 Hz), sine		$V_R = 0$ V		2.21	kA
I^2t	value for fusing	$t = 10$ ms; (50 Hz), sine		$T_{VJ} = 45^{\circ}C$		28.8	kA ² s
		$t = 8,3$ ms; (60 Hz), sine		$V_R = 0$ V		27.9	kA ² s
		$t = 10$ ms; (50 Hz), sine		$T_{VJ} = 150^{\circ}C$		20.8	kA ² s
		$t = 8,3$ ms; (60 Hz), sine		$V_R = 0$ V		20.2	kA ² s
C_J	junction capacitance	$V_R = 400$ V; $f = 1$ MHz		$T_{VJ} = 25^{\circ}C$		91	pF

Package E3-Pack		Ratings				
Symbol	Definition	Conditions	min.	typ.	max.	Unit
I_{RMS}	RMS current	per terminal			30	A
T_{VJ}	virtual junction temperature		-40		150	°C
T_{op}	operation temperature		-40		125	°C
T_{stg}	storage temperature		-40		125	°C
Weight				270		g
M_D	mounting torque		3		6	Nm
$d_{Spp/App}$	creepage distance on surface / striking distance through air	terminal to terminal	6.0			mm
$d_{Spb/Apb}$		terminal to backside	12.0			mm
V_{ISOL}	isolation voltage	t = 1 second	3600			V
		t = 1 minute	3000			V

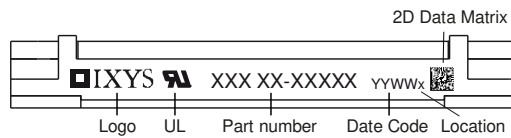

Part description

- M = Module
- D = Diode
- M = Standard Rectifier
- A = (up to 1800V)
- 450 = Current Rating [A]
- U = 3- Rectifier Bridge
- 1600 = Reverse Voltage [V]
- PT = PressFit-Pin, Thermistor
- EH = E3-Pack
- = Hyphen
- PC = Phase Change Material

Ordering	Ordering Number	Marking on Product	Delivery Mode	Quantity	Code No.
Standard	MDMA450U1600PTEH	MDMA450U1600PTEH	Blister	24	
Alternative	MDMA450U1600PTEH-PC	MDMA450U1600PTEH	Blister	24	518562

Temperature Sensor NTC

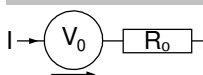
Symbol	Definition	Conditions	min.	typ.	max.	Unit
R_{25}	resistance	$T_{VJ} = 25^\circ$	4.85	5	5.15	k Ω
$B_{25/50}$	temperature coefficient			3375		K

Equivalent Circuits for Simulation
** on die level*
 $T_{VJ} = 150^\circ\text{C}$

Rectifier

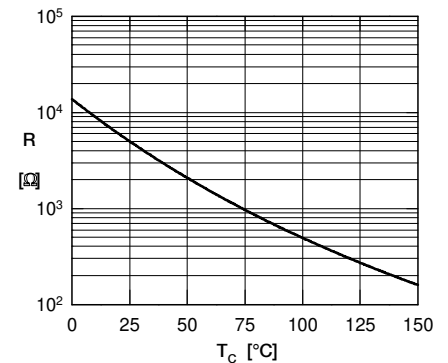
$V_{0\ max}$	threshold voltage	0.82				V
$R_{0\ max}$	slope resistance *	1.2				m Ω

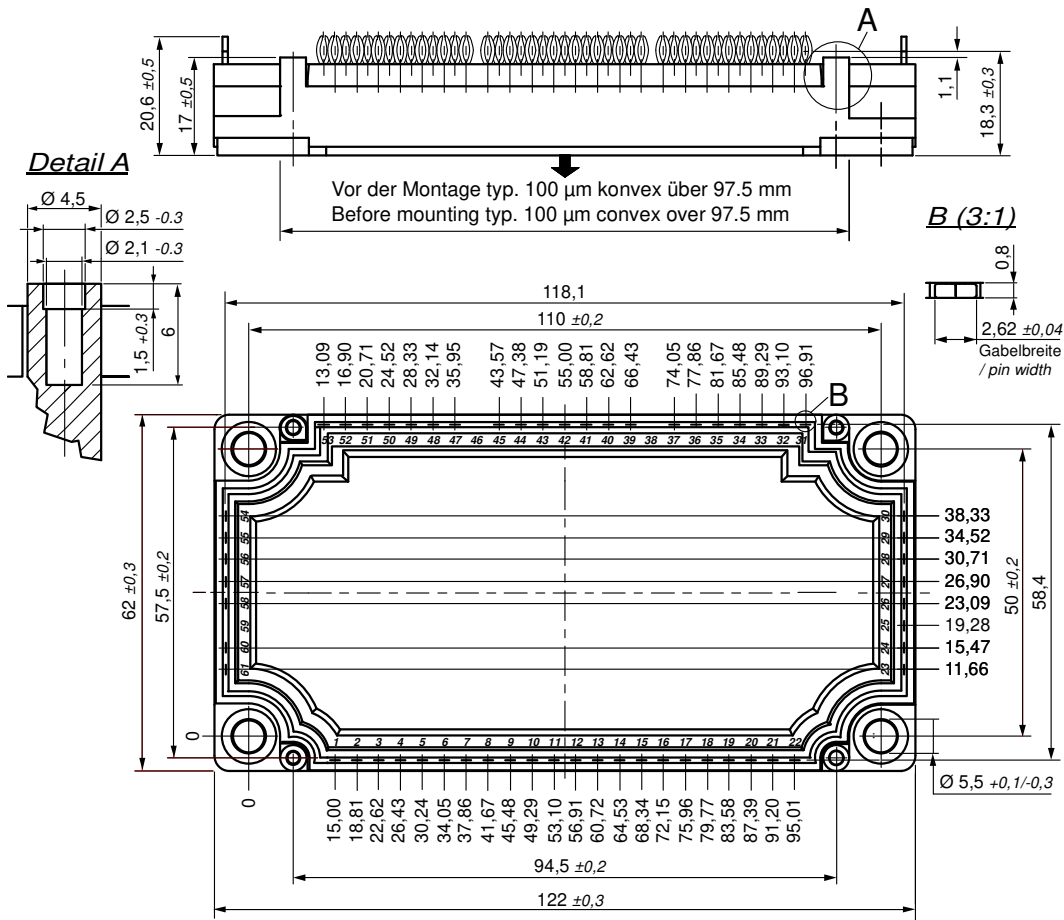

Outlines E3-Pack



Bemerkung / Note:

- Nichttolerierete Maße nach / Measure without tolerances according DIN ISO 2768-T1-m
- PCB-Lochmuster / PCB hole pattern: **see pin position**
- Toleranz Pin-Position und PCB-Lochmuster / Tolerance of pin position and PCB hole pattern: $\oplus 0.1$
- Bohrlochdurchmesser / Diameter of drill: **Ø 2.35 mm**
- Endlochdurchmesser / Diameter of plated holes: **Ø 2.14 - 2.29 mm** (Cu thickness in via typ. 50 µm)
- Beschichtung / Plating: **chem. Sn max. 15 µm**
- Einpresskraft / Insert Force: per terminal with a typ. insert speed of 7 mm/s: **typ. 90 N**
- Weitere Angaben / Further information: www.ixys.com **Application note IXAN0077**
- Montageanleitung / Mounting instruction: www.ixys.com **Application note IXAN0024**

Detail A: PCB-Montage / Mounting on PCB¹

- Empfohlene, selbstschneidende Schraube / Recommended, self-tapping screw: **EJOT PT®** (Größe / size: **K25**)¹
- Max. Schraubenlänge / Max. screw length: **PCB-Dicke / thickness + 6 mm** (max. Lochtiefe / hole depth)¹
- Empfohlenes Drehmoment / Recommended mounting torque: **1.5 Nm**

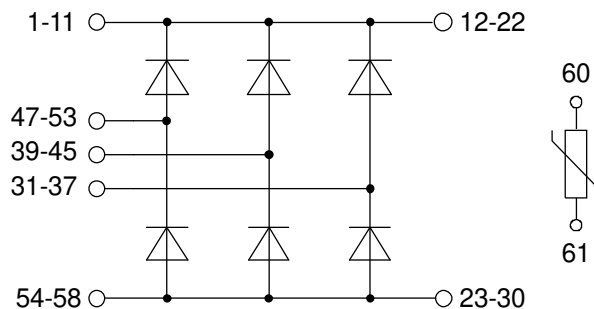

Rectifier

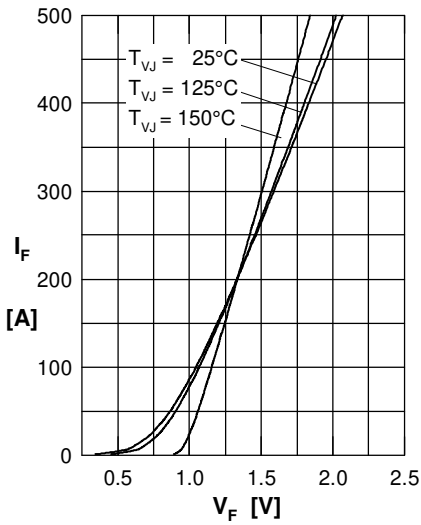

Fig. 1 Forward current versus voltage drop per diode

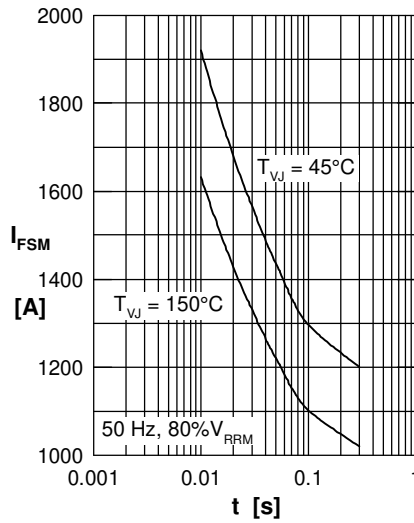

Fig. 2 Surge overload current vs. time per diode

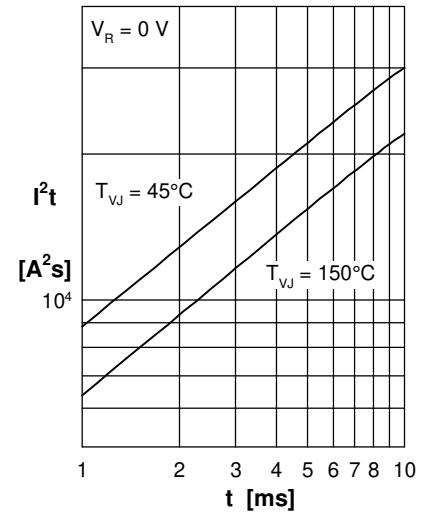

Fig. 3 I^2t versus time per diode

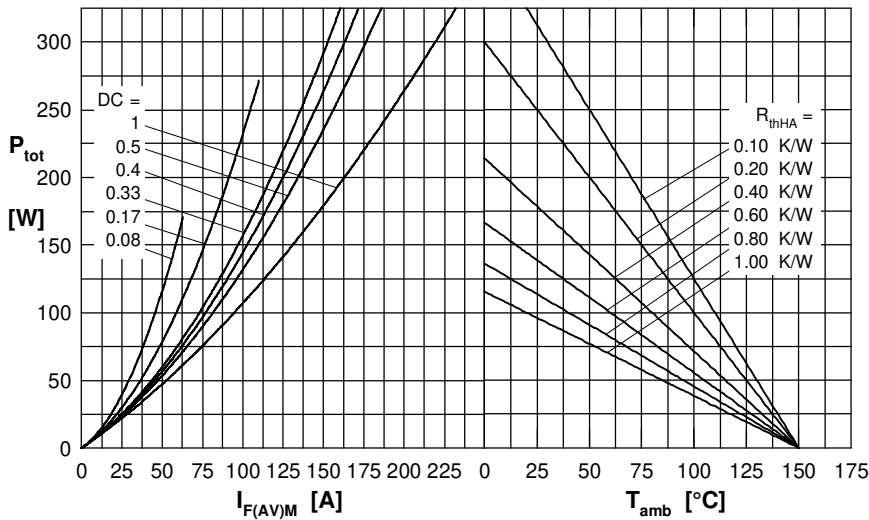

Fig. 4 Power dissipation vs. forward current and ambient temperature per diode

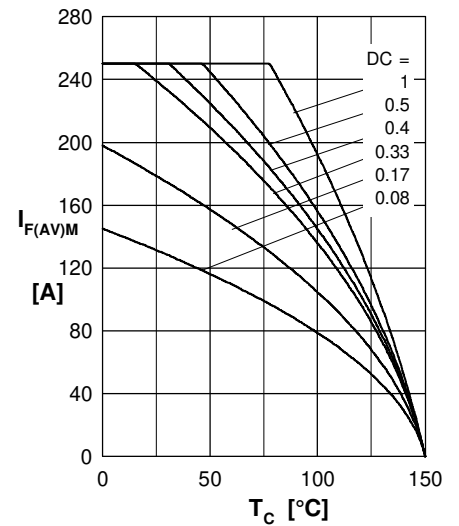

Fig. 5 Max. forward current vs. case temperature per diode

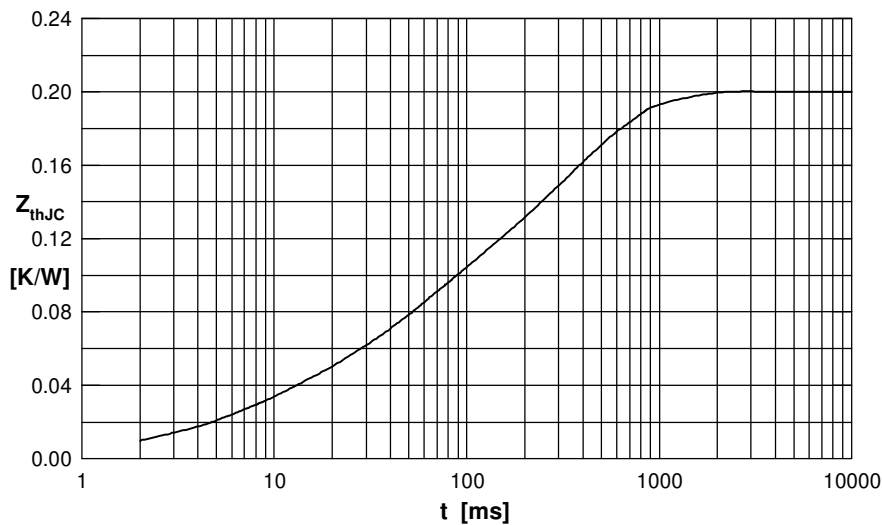

Fig. 6 Transient thermal impedance junction to case vs. time per diode

Constants for Z_{thjC} calculation:

i	R_{thi} (K/W)	t_i (s)
1	0.020	0.006
2	0.003	0.007
3	0.057	0.042
4	0.120	0.350